



The HMX series of Gefran are pressure transmitters with HART communication protocol for using in high temperature environment with explosive atmosphere presence.

The main characteristic of this series is the capability to read temperature of the media up to 400°C.

The constructive principle is based on the hydraulic transmission of the pressure.

The fluid-filled system assures the temperature stability. The physical measure is transformed in a electrical measure by means of strain-gauge technology.

### MAIN FEATURES

- Pressure ranges from: 0-17 a 0-2000 bar/0-250 a 0-30000 psi
- Extensimetric measurement principle with Wheatstone bridge
- Accuracy: <math>\pm 0.25\%</math> FSO (H); <math>\pm 0.5\%</math> FSO (M)
- Calibration signal 80% FSO internally generated
- Completely interchangeable with all existing products
- Protection level: IP65 (6-pin connector)
- 1/2-20UNF, M18x1.5 standard threads; other types available on request
- Standard diaphragm is 15-5 PH stainless steel with GTP coating
- 17-7 PH corrugated stainless steel diaphragm with GTP coating for ranges below 100 bar-1500 psi
- Other diaphragm types available on request

**HMX0** The rigid rod configuration provides fast and easy installation.

**HMX1** The flexible rod configuration is suitable for applications demanding greater thermal isolation and where installation would otherwise be difficult.

**HMX2** This configuration lets you measure process pressure and temperature at the same point with a single installation.

**HMX3** The configuration with exposed tip is ideal for applications in limited space.

#### Main intrinsic safety characteristics

The transmitters are designed and built in conformity to EN 60079-0: 2009, EN60079-11:2012, EN60079-26:2007.

Protection mode: group II, category 1GD

GAS protection mode: Ex ia IIC T6, T5, T4 Ga (Ambient Temp.: -20°C...+60°C / +75°C / +85°C)

DUST protection mode: Ex ia IIIC T85°C, T100°C, T135°C Da IP65 (Ambient Temp.: -20°C...+60°C / +75°C / +85°C)

Maximum voltage	30 V
Maximum current	100 mA
Maximum power	0,75 W
Maximum inductance (*)	1,05 mH
Maximum capacity (*)	10 nF

(\*) includes inductance levels and capacity of a cable: (typical L 1microH/m and typical C 100pF/m) with maximum length 15m.

### TECHNICAL SPECIFICATIONS

Accuracy (1)	H <math>\pm 0.25\%</math>FSO (100...2000 bar) M <math>\pm 0.5\%</math>FSO (17...2000 bar)
Resolution	16 bit
Measurement range	0..17 to 0..2000bar 0..250 to 0..30000psi
Rangeability	3:1
Maximum overpressure (without degrading performances)	2 x FS 1.5 x FS above 1000bar/15000psi
Measurement principle	Extensimetric
Power supply	13...30Vdc
Maximum current absorption	23mA
Output signal Full Scale (FSO)	20mA
Zero balance (tolerance $\pm 0.25\%$ FSO)	4mA
Calibration signal	80% FSO
Power supply polarity reverse protection	YES
Compensated temperature range housing	0...+85°C
Operating temperature range housing	-30...+85°C
Storage temperature range housing	-40...+125°C
Thermal drift in compensated range: Zero / Calibration / Sensibility	<math>< 0.02\%</math> FSO/°C
Diaphragm maximum temperature	400°C / 750°F
Zero drift due to change in process temperature (zero)	<math>< 0.02</math> bar/°C
Standard material in contact with process medium	Diaphragm: • 15-5 PH with GTP coating • 17-7 PH corrugated diaphragm with GTP coating for ranges <math>< 100\text{bar}</math> (1500psi) Stem: • 17-4 PH
Thermocouple (model HMX2)	STD: type "J" (isolated junction)
Protection degree (with 6-pole female connector)	IP65
FSO = Full scale output (1) BFSL method (Best Fit Straight Line): includes combined effects of Non-Linearity, Hysteresis and Repeatability	

The Melt pressure transmitters must be connected to other equipment (galvanic isolation barriers) with individual ATEX certification such as [Ex ia Ga] IIC. The thermocouple circuit must be powered by means of galvanic isolation barriers with a maximum of 30V.



EC-Type Examination Certificate number: **DNV 13 ATEX 3894**

# MECHANICAL DIMENSIONS

## HMX0

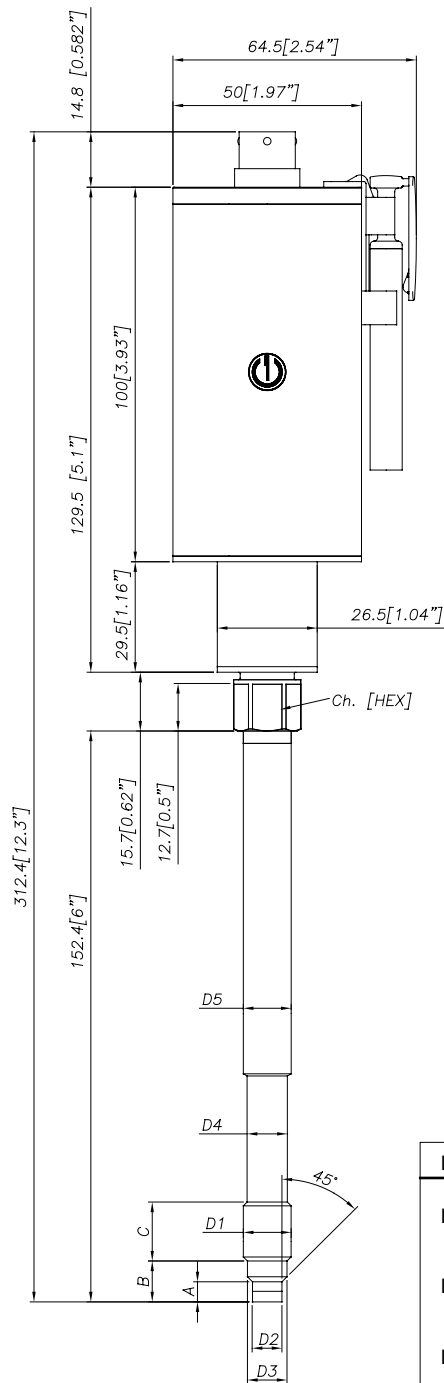

## HMX1

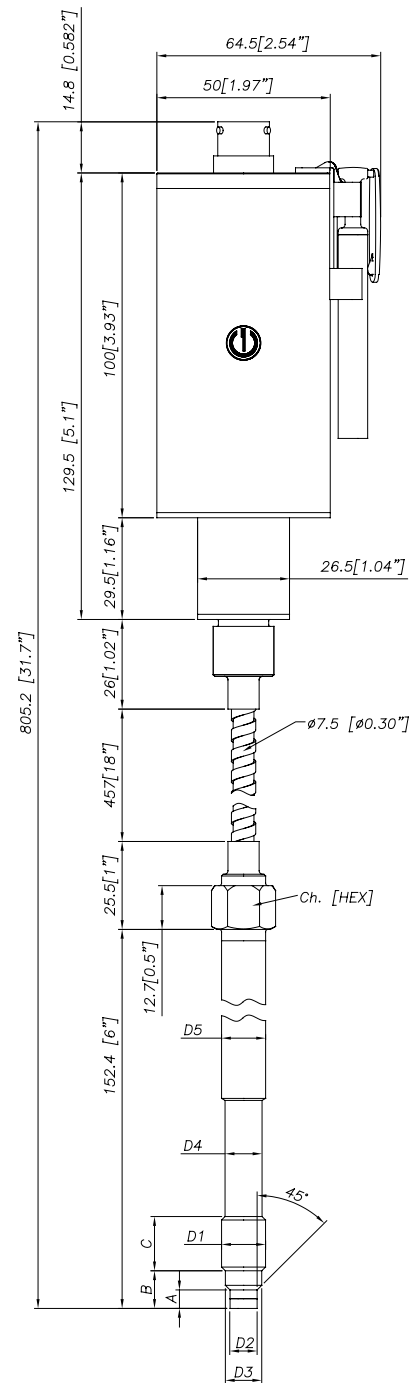

D1	1/2 - 20UNF	D1	M18x1.5
D2	ø7.8 -0.05 [ø0.31" -0.002]	D2	ø10 -0.05 [ø0.394" -0.002]
D3	ø10.5 -0.025 [ø0.41" -0.001]	D3	ø16 -0.08 [ø0.63" -0.003]
D4	ø10.67 [ø0.42"]	D4	ø16 -0.4 [ø0.63" -0.016]
D5	ø12.7 [ø0.5"]	D5	ø18 [ø0.71"]
A	5.56 -0.26 [0.22" -0.01]	A	6 -0.26 [0.24" -0.01]
B	11.2 [0.44"]	B	14.8 -0.4 [0.58" -0.016]
C	15.74 [0.62"]	C	19 [0.75"]
Ch [Hex]	16 [5/8"]	Ch [Hex]	19 [3/4"]

**NOTE:** dimensions refer to rigid stem length option "4" (153 mm– 6")

**WARNING:** For installation use a maximum tightening torque of 56 Nm (500 in-lb)

# MECHANICAL DIMENSIONS

## HMX2

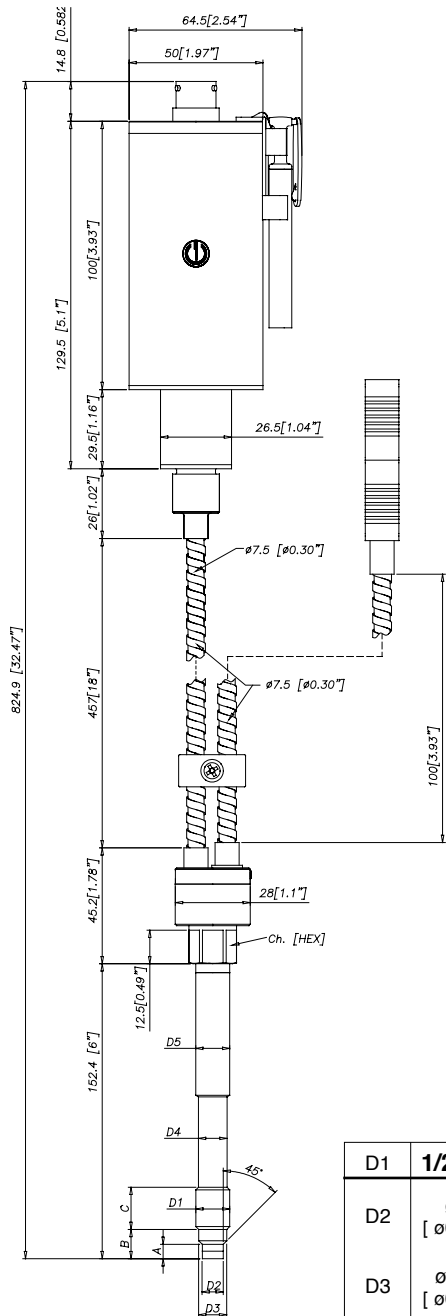

## HMX3

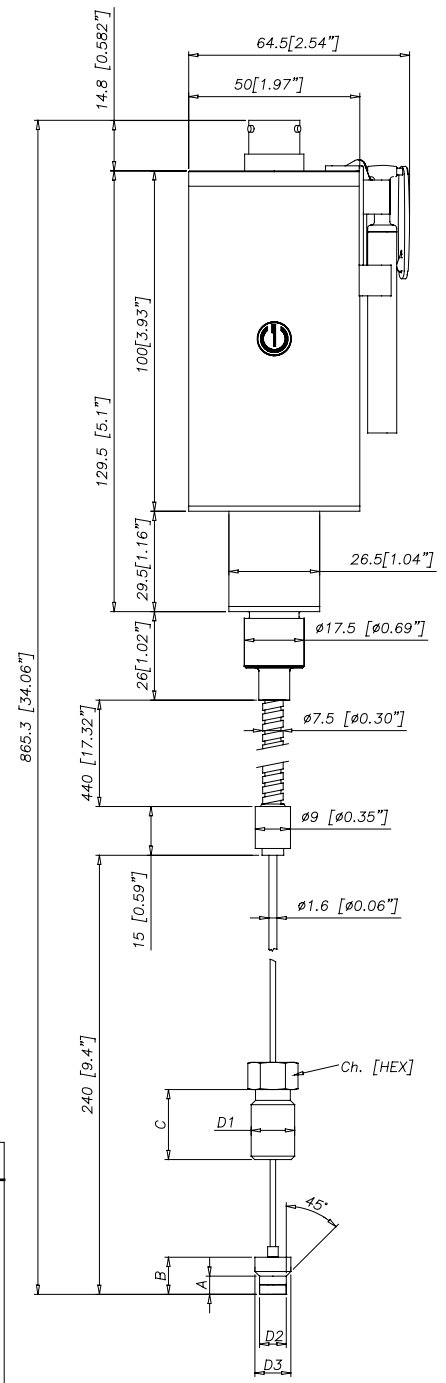

D1	1/2 - 20UNF	D1	M18x1.5
D2	$\phi 7.8 -0.05$ [ $\phi 0.31 -0.002$ ]	D2	$\phi 10 -0.05$ [ $\phi 0.394 -0.002$ ]
D3	$\phi 10.5 -0.025$ [ $\phi 0.41 -0.001$ ]	D3	$\phi 16 -0.08$ [ $\phi 0.63 -0.003$ ]
D4	$\phi 10.67$ [ $\phi 0.42$ ]	D4	$\phi 16 -0.4$ [ $\phi 0.63 -0.016$ ]
D5	$\phi 12.7$ [ $\phi 0.5$ ]	D5	$\phi 18$ [ $\phi 0.71$ ]
A	$5.56 -0.26$ [ $0.22 -0.01$ ]	A	$6 -0.26$ [ $0.24 -0.01$ ]
B	$11.2$ [ $0.44$ ]	B	$14.8 -0.4$ [ $0.58 -0.016$ ]
C	$15.74$ [ $0.62$ ]	C	$19$ [ $0.75$ ]
Ch [Hex]	$16$ [ $5/8$ ]	Ch [Hex]	$19$ [ $3/4$ ]

**NOTE:** dimensions refer to rigid stem length option "4" (153 mm– 6")

**WARNING:** For installation use a maximum tightening torque of 56 Nm (500 in-lb)

## SELF DIAGNOSTICS (ONLY FOR PL'C' VERSIONS)

Below the conditions detected by the sensor self-diagnostics:

- Cut cable / device non connected / broken power supply, output  $\leq 3.6\text{mA}$
- Pin detachment output  $\leq 3.6\text{mA}$
- Broken primary element  $\geq 21\text{mA}$
- Pressure above 200% of the span, output  $\geq 21\text{mA}$
- Voltage monitor in case of overvoltage/undervoltage/voltage variation in the electronics, output  $\leq 3.6\text{mA}$  (\*)
- Program sequence error, output  $\leq 3.6\text{mA}$  (\*)
- Overtemperature on the electronics, output  $\leq 3.6\text{mA}$  (\*)
- Error on the primary element output or on the first amplification stage, output  $\leq 3.6\text{mA}$  (\*)

(\*) In such conditions the Alarm Type can be programmed via HART at  $\geq 21\text{mA}$ .

## NAMUR COMPLIANCE (ONLY FOR PL'C' VERSIONS)

The sensors are tested according to Namur NE21 recommendations. The same compatibility is valid for the NE43 Namur recommendation with the following sensor behaviour in case of breakdown:

- Cut cable: breakdown information as the signal is  $\leq 3.6\text{mA}$
- Device not connected: breakdown information as the signal is  $\leq 3.6\text{mA}$
- Broken power-supply: breakdown information as the signal is  $\leq 3.6\text{mA}$
- or in case of performance problems:
- Broken primary element  $\geq 21\text{mA}$
- Pressure above 200% of the span, output  $\geq 21\text{mA}$
- Others  $\leq 3.6\text{mA}$ (\*)

(\*) In such a condition the Alarm Type can be programmed via HART at  $\geq 21\text{mA}$ .

Note: in all the remaining situations, the output signal is always included between 3.8 and 20.5mA.



**Recommendation:** the error level set by the customer (e.g. maximum pressure value) has to be inside the nominal range.

## LOAD DIAGRAM

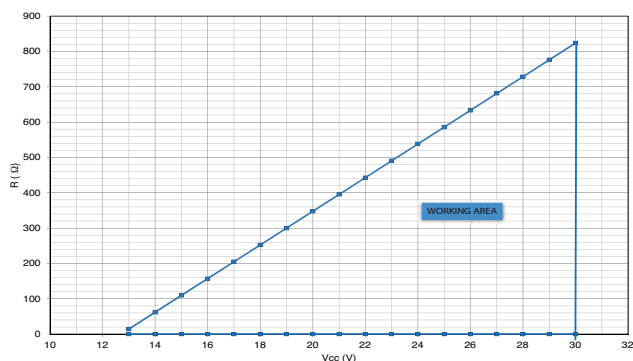

The diagram shows the optimum ratio between load and power supply for transmitters with 4...20mA output. For correct function, use a combination of load resistance and voltage that falls within the two lines in the graph above.

## AUTOZERO FUNCTION

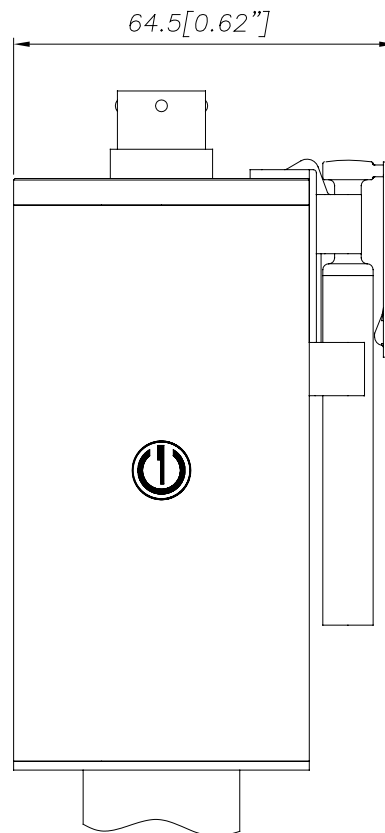

The Autozero function is activated through a magnetic contact (external magnet supplied with the sensor). The Autozero function can be activated through HART command as well. See the manual for a complete Autozero function explanation.

# ELECTRICAL CONNECTIONS

## CURRENT OUTPUT

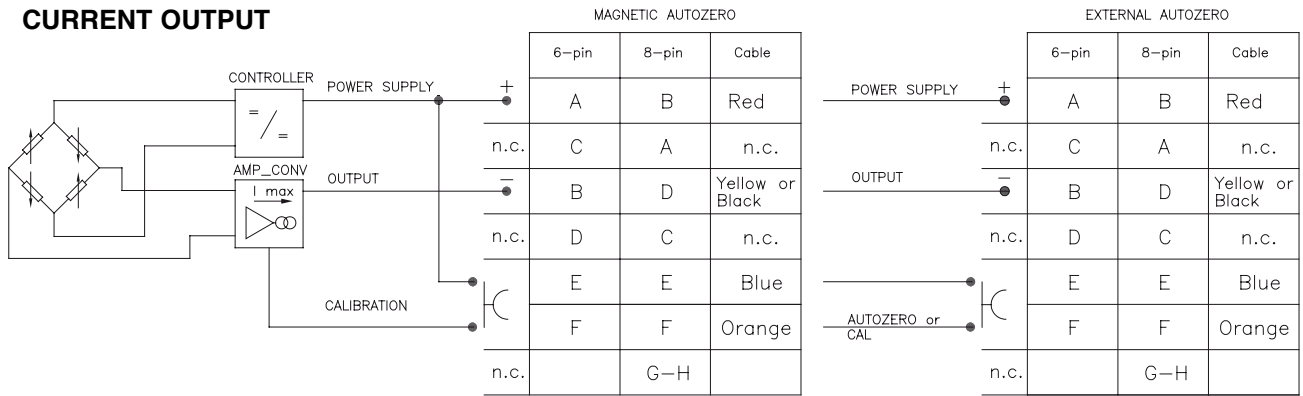

The cable shield is tied to both sides, i.e. to the sensor connector and to the controller

### 6 pin Connector VPT07RA10-6PT2 (PT02A-10-6P)

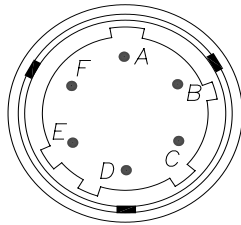

### 8 pin Connector (PC02E-12-8P) Bendix

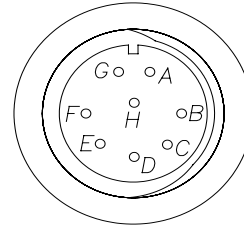

### Cable outlet (1/2 14-NPT) Current output L = 1 m

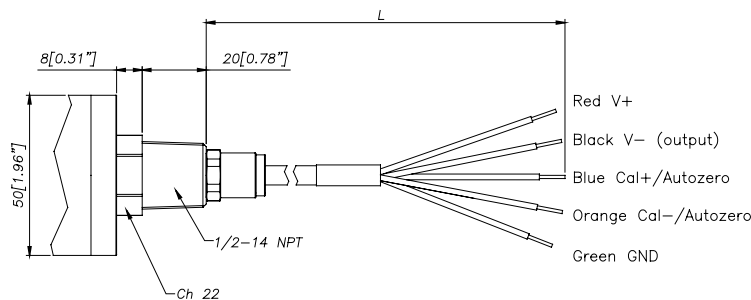

## ACCESSORIES

### Connectors

6-pin female connector (IP65 protection degree)  
8-pin female connector

CON300  
CON307

### Accessories

Mounting bracket  
Dummy plug for 1/2-20UNF  
Dummy plug for M18x1.5  
Drill kit for 1/2-20UNF  
Drill kit for M18x1.5  
Cleaning kit for 1/2-20UNF  
Cleaning kit for M18x1.5  
Fixing pen clip  
Autozero pen

SF18  
SC12  
SC18  
KF12  
KF18  
CT12  
CT18  
PKIT1032  
PKIT378

### Extension cables

6-pin connector with 3mt Atex cable  
6-pin connector with 4mt Atex cable  
6-pin connector with 5mt Atex cable  
6-pin connector with 10mt Atex cable

PCAV221  
PCAV104  
PCAV105  
PCAV106

### Thermocouples for model HMX2

Type "J" (for rigid rod 153mm - 6")

TTER 601

Cable color code	
Conn.	Wire
A-2	Red
B-4	Black
C-1	White
D-6	Green
E-7	Blue
F-3	Orange
5	Grey
8	Pink

# ORDER CODE

HM - - - - - 0000 X 000 X 0

000= Special executions

OUTPUT SIGNAL	
4...20mA	X

VERSION	
Rigid rod	0
Rigid + flexible rod	1
With thermocouple	2
Exposed capillary	3

CONNECTOR	
6 pin	6
8 pin	8
NPT Cable	N

ACCURACY CLASS	
0.25% FSO (ranges ≥ 100 bar/1500 psi)	H
0.5% FSO	M

MEASUREMENT RANGE			
bar		psi	
17	B17U	250	P25D
35	B35U	500	P05C
50	B05D	750	P75D
70	B07D	1000	P01M
100	B01C	1500	P15C
200	B02C	3000	P03M
350	B35D	5000	P05M
500	B05C	7500	P75C
700	B07C	10000	P10M
1000	B01M	15000	P15M
1400	B14C	20000	P20M
2000	B02M	30000	P30M

THREADING	
Standard	
1/2 - 20 UNF	1
M18 x 1.5	4
Available on request	
M10 x 1 (range ≥200bar / 3000psi)	2
M14 x 1.5	3

4	T4 Ex ia IIC T4 Ga (Tambient: -20°C...+85°C)/Ex ia IIIC T135°C Da IP65
5	T5 Ex ia IIC T5 Ga (Tambient: -20°C...+75°C)/Ex ia IIIC T100°C Da IP65
6	T6 Ex ia IIC T6 Ga (Tambient: -20°C...+60°C)/Ex ia IIIC T85°C Da IP65

E	External Autozero (*)
0	Magnetic Autozero
(*) as an alternative to the CAL function	

P	Performance Level='c'
0	Standard 4...20mA

FLEXIBLE ROD LENGTH (mm/inches)		
Standard (HMX0)		
0	none	
Standard (HMX1, HMX2)		
D	457mm	18"
E	610mm	24"
F	760mm	30"
Standard (HMX3)		
L	711mm	28"
Available on request		
A	76mm	3"
B	152mm	6"
C	300mm	12"
G	914mm	36"
H	1067mm	42"
I	1220mm	48"
J	1372mm	54"
K	1520mm	60"

RIGID ROD LENGTH (mm/inches)		
Standard (HMX0, HMX1, HMX2)		
4	153mm	6"
5	318mm	12.5"
Standard (HMX3)		
0	none	
Available on request		
1	38mm	1.5"
2	50mm	2"
3	76mm	3"
6	350mm	14"
7	400mm	16"
8	456mm	18"

Example

**HMX1-6-M-B07C-1-4-D-0-0-4**

Melt pressure transmitter, 4...20mA output with HART protocol, 6-pin connector, 1/2-20 UNF threading, 700 bar pressure range, 0.5% accuracy, 153 mm (6") rigid rod, 457 mm (18") flexible rod, temperature class T4 (-20°C...+85°C).

Sensors are manufactured in compliance with:

- EMC 2004/108/CE compatibility directive
- RoHS 2002/95/CE directive
- ATEX 94/9/CE directive
- 2006/42/CE machinery directive

Electrical installation requirements and conformity certificate are available on our web site: [www.gefran.com](http://www.gefran.com)

GEFRAN spa reserves the right to make any kind of design or functional modification at any moment without prior notice.

**GEFRAN spa**  
 via Sebina, 74  
 25050 PROVAGLIO D'ISEO (BS) - ITALIA  
 tel. 0309888.1 - fax. 0309839063  
 Internet: <http://www.gefran.com>

**GEFRAN**

DTS\_HMX\_11-2013\_ENG