



FEMA ELECTRÓNICA, S.A.



CONVERTER-TRANSMITER .- Series CCT

CCT- 20 .- for PT100 Signals

CCT- 90 .- Potentiometer Signals

CCT- 95 .- Resistance Signals

P.I. Santiga Altimira 14 (Talleres 14, Nave 2) E 08210-BARBERÀ DEL VALLÈS (SPAIN)
 Tel: (+34) 93.729.6004 Fax : (+34) 93.729 .6003 fema@fema.es www.fema.es

1.- COMMON TECHNICAL SPECIFICATIONS

Output 0/20mA ó 4/20mA	$R_L < 600$ Ohms max. 22 mA $\pm 3\%$
Output 0/10 Vdc	$R_L > 1000$ Ohms max. 11 V $\pm 3\%$
Response Time	≤ 250 mSec
Galvanic Isolation	2 KV _{eff.} 50 Hz/1 min (between all circuits)
Isolation Test	4 KV _{eff.} 50 Hz/1min
Accuracy	Class <0,2 for CCT-20, CCT-90 and CCT-95
Ripple	$\leq 0,5$ %
Pass Band	1,5 Hz (-3 dB)
Storage Temperature	-30 to +80 °C (-22 to +176 °F)
Working Temperature	-10 to +60 °C (+14 to +140 °F)
Temperature Coef.	$\leq 0,015$ %/ °C
Power Supply	See label on instrument
Consumption	<1,5 VA
Weight	270 gr.
Wire Crossection	4 mm ² maximum
Housing and Cover	IP-40
Terminals	IP-20
Housing and Cover	Polycarbonate, Light Grey, RAL 7032, UL 94 V-1
Terminals	Polycarbonate, Dark Grey, UL 94 V-2
Mounting	Standard DIN rail (DIN 46277, DIN EN 50022) (35 x 7,5mm) (1,38 x 0,3") .

MECHANICAL DIMENSIONS in mm (inches)

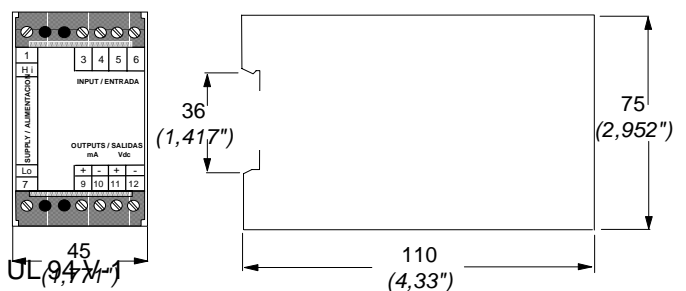

2.- ADJUST AND CALIBRATION PROCEDURE

- 1.- Open the housing to access the instrument internal circuits
- 2.- Select appropriate jumpers on boards ME, MP and MS
- 3.- Connect signal generator to signal input terminals
Connect multimeter to signal output terminals
- 4.- Power up the instrument as indicated on the label
- 5.- Generate the signal level low
Operate potentiometer P1 on ME until indication shows desired signal output low level
- 6.- Generate the signal level high
Operate potentiometer P2 on ME until indication shows desired signal output low level
- 7.- Repeat steps 6 to 9 in order to correct deviations and check adjust

3.- ACCESS TO INTERNAL CIRCUITS

- 1.-With a flat screwdriver, force the front cover and walls towards **A** and **B**, until fixations '3' are free.
- 2.-Take the instrument from points '2', and extract it pulling towards **C**, until the internal circuits appear.
- 3.-Internal circuits are connected with the help of pins and allow access to potentiometers and jumpers for range adjustment.
- 4.- When introducing back the housing, check position of front cover (Terminals 1 and 7 separated from the others) and introduce it in the correct guides.

- ME .- Signal Input Module
- MS .- Signal Output Module
- MA .- Power Module
- MP .- Personalizer Module

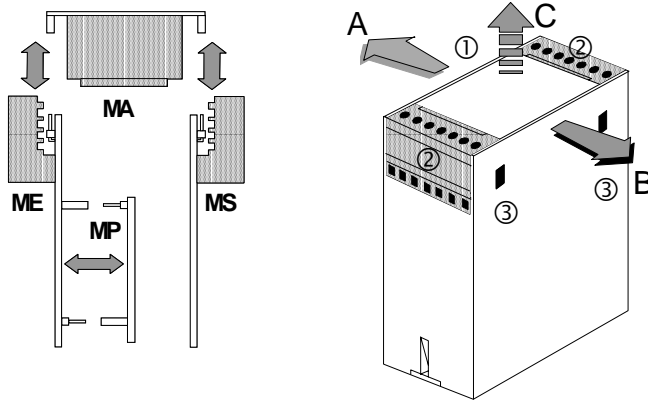

4.- POWER SUPPLY CONNECTIONS

Power Supply connected on terminals 1 and 7. It is recommended the following connection, including protection fuse and mains switch.

POWER	FUSE
230 Vac	50 mA
115 Vac	100 mA
48 Vac	150 mA
24 Vac	300 mA
24 Vdc	300 mA

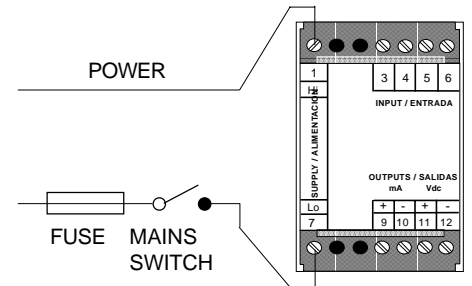

5.- OUTPUT SIGNAL .- SELECTION AND CONNECTIONS

Instrument CCT allows outputs in voltage and current. Only one of this outputs is active at the same time. It is possible to reconfigure the instrument to any of the indicated output signals below, plus the 4/20 mA and 0/10 Vdc signals allowed by default.

NOTE .- The current loop generated by the CCT is ACTIVE. The CCT powers the current loop. Do NOT connect the output loop to elements which are also active. This will damage both elements.

Jumper E and F Closed .- Outputs 4/20 mA
 Jumper E and F Opens.- Other Outputs

Resistances in Ohms			
OUTPUT	R18	R24	R25
0/5mA	---	100	---
0/10mA	---	49,9	---
1/5mA	100K	124	---
0/20mA	---	---	24,9

NOTE : ' - - - ' resistance NOT installed

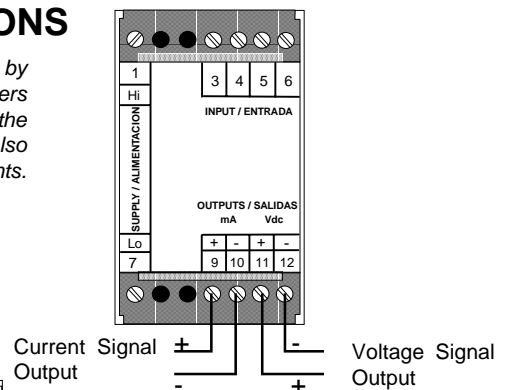
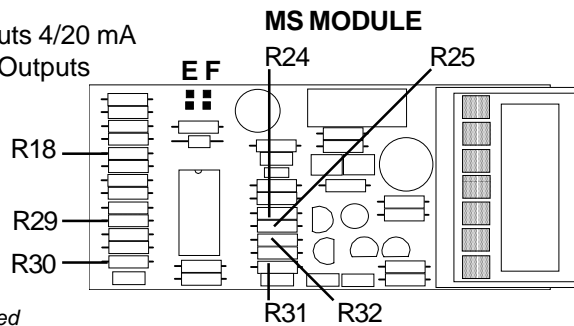

Resistances in KOhms				
OUTPUT	R29	R30	R31	R32
±10Vdc	49,9	---	200	---
0/1Vdc	---	---	11	100
0/5Vdc	---	---	100	100
1/5Vdc	---	100	66,5	100

NOTE : ' - - - ' resistance NOT installed

6.- INPUT SIGNAL MODULE

The ME module together with MP module, allow configuration of different input signal ranges, and calibrate the instrument. On the ME are located the potentiometers and jumpers for Zero and Gain adjustment. On MP modules are located the jumpers for signal input configuration.

- Jumper 1 .- Closed for Gross Positive Offset
- Jumper 2 .- Closed for Gross Negative Offset
- Jumper A .- Closed for Fine Negative Offset

- Jumper B .- Closed for Maximum GAIN
- Jumper C .- Closed for Middle GAIN
- Jumper B y C .- Open for Minimum GAIN

Note : jumpers 1,2,A,B and C normally OPEN

- P1 .- Zero Adjust Potentiometer
- P2 .- Gain Adjust Potentiometer

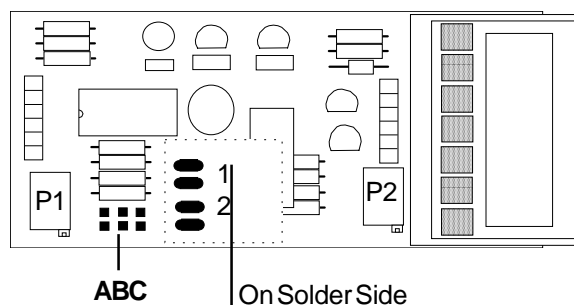

7.- MODEL 20 .- RANGES, JUMPERS, CONNECTIONS

The CCT converter can be configured in order to adequate the input and output signal ranges to the final application. For thermoresistance PT100 / RTD signals, according to DIN 43760, for 2 and 3 wires techniques.

RANGE	0/100°C	0/200 °C	0/300°C	0/400°C	0/500°C	0/600°C
ME Jumpers Closed	B	C	C	Ninguno	Ninguno	Ninguno
Minimum Input Span	50°C	50°C	50°C	50°C	50°C	50°C
Current through Sensor	< 1mA					
Sensor Break Detection	Output signa goes lower than the minimum output signal (<4mA for example)					
Minimum Input Span.-	Minimum range at input in order to have a maximum output range in 0/10 Vdc or 4/20 mA.					

In 2 wire technique connections the automatic compensation of the measure wire resistance is not activated.

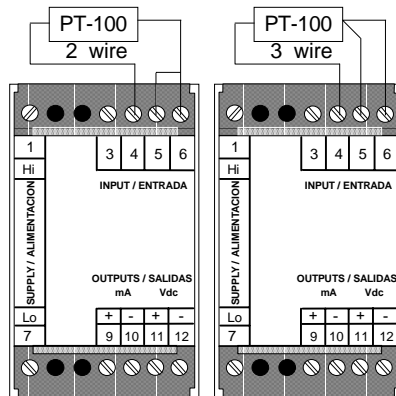

8.- MODEL 90.- RANGES, JUMPERS, CONNECTIONS

The CCT converter can be configured in order to adequate the input and output signal ranges to the final application. Accepts potentiometric type signals. Potentiometer values between 100 Ohms and 1 MOhm. By default, units are configured at 0/100% of the potentiometer range, although it is possible to adjust only a part of the potentiometer range.

RANGE	0/100%
ME Jumpers Closed	A,B,C OPEN
Terminal Connections	3,4 and 5

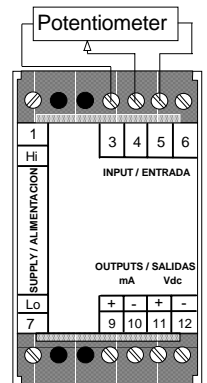

9.- MODEL 95 .- RANGES, JUMPERS, CONNECTIONS

The CCT converter can be configured in order to adequate the input and output signal ranges to the final application. 2 Wire measuring technique. Does not apply automatic compensation of the measure wire resistances. Maximum admisible resistance is 1 MOhm

RANGE	0/200 Ohms	0/2KOhms	0/20 KOhms	0/200 KOhms
MP Jumpers Closed	5	6	7	None
ME Jumpers Closed	A,B,C OPEN			
Minimum Input Span	10% of Full Scale used			

Minimum Input Span.- Minimum range at input in order to have a maximum output range in 0/10 Vdc or 4/20 mA.

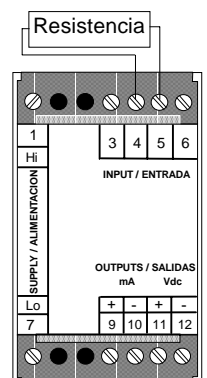
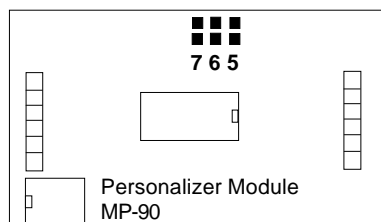

11.- PRELIMINARY NOTES



INSTALLATION.- PRECAUTIONS

The installation and use of this unit must be done by qualified personnel. The unit has not AC (mains) switch, neither internal protection fuse. It will be in operation as soon as power is connected. The installation must incorporate an external mains switch with a protection fuse in the power line

Power : 230 Vac Fuse 50 mA
 Power : 115 Vac Fuse 100 mA
 Power : 24 Vdc Fuse 300 mA

Add the appropriate devices to the installation in order to protect the operator and system when using the unit to control a machine or process where injury to personnel or damage to equipment may occur as a result of failure of the unit.



SAFETY PRESCRIPTIONS.- This unit has been designed and tested under EN-61010-1 rules and is delivered in good condition. This operator's manual contains useful information for electrical connections. Do not make wiring signal changes or connections when power is applied to the unit. Make signal connections before power is applied and, if reconnection is required, disconnect the AC (mains) power before such wiring is attempted. Install the unit in a place with a good ventilation to avoid the excessive heating. And far from electrical noise source or magnetic field generators such as power relays, electrical motors, speed controls etc... The unit cannot be installed in open places. Do not use until the installation is finished.

POWER SUPPLY.- The power supply must be connected to the adequate terminals (see the connection instructions). The characteristics of the power supply are shown on the side label. Please make sure that the unit is correctly connected to a power supply of the correct voltage and frequency. Do not use other power supply otherwise permanent damage may be caused to the unit. Do not connect the unit to power sources heavily loaded or to circuits which power loads in cycle ON-OFF or to circuits which power inductive loads.

WARNING.- If the power supply is dc voltage, be careful with the polarity indicated for each terminal.

EXCITATION VOLTAGE.- The model CCT-32 supply the Excitation voltage for sensors, through the terminals 3 & 5. Do not connect these terminals to other external power supply, permanent damages may result to the unit.

SIGNAL WIRING.- Certain considerations must be given when install the signal input wires. If the wires are long can act like an antenna and introduce the electrical noise to the unit, therefore: Do not install the signal input wires in the same conduit with power lines, heaters, solenoids, SCR controls etc...and always far from these elements. When shielded wires are used, leave unconnected the shield on the transmitter side and connect the other end of the shield to the ground terminal of the machine.

SAFETY CONSIDERATIONS

PRESCRIPTIONS.- Before starting any operation of adjustment, replacement, maintenance or repair, the unit must be disconnected from any kind of power supply. Keep the unit clean, to assure good functioning and performance.

To prevent electrical or fire hazard, do not expose the unit to excessive moisture. Do not operate the unit in the presence of flammable gases or fumes, such an environment constitutes a definite safety hazard. The unit is designed to be mounted in a metal panel. If the unit shows signs of damage, or is not able to show the expected measures, or has been stored in a bad conditions or a protection failure can occur, then do not attempt to operate and keep the unit out of service.

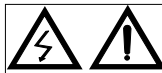

IN CASE OF FIRE

- 1.- Disconnect the unit from the power supply.
- 2.- Give the alarm according to the local rules.
- 3.- Switch off all the air conditioning devices.
- 4.- Attack the fire with carbonic snow, do not use water in any case.



WARNING : In closed areas do not use systems with vaporized liquids.



DECLARATION OF CONFORMITY

Manufacturer: **FEMA ELECTRÓNICA, S.A.**
 Address: Centro Industrial Santiga
 c\ Altimira, 14 (Talleres 14 - Nave 2)
 E-08210 - Barberà del Vallès (ESPAÑA)
 Products Covered: SERIES : CCT MODELS : 20, 90, 95

We declare that the above referenced instruments comply with the valid rules and regulations detailed below :

REGULATIONS:

EUROPEAN DIRECTIVE FOR LOW VOLTAGE D73/23/CEE AMENDED BY D93/68/CEE. Equipments powered from 50 to 1000 Vac. and /or from 75 to 1500 Vdc.

EUROPEAN DIRECTIVE FOR THE SAFETY D92/59/CEE. ELECTROTECHNICAL REGULATION FOR LOW VOLTAGE (RBT) ITC 21, ITC 29, ITC 35. Equipments with power supply lower than 50 Vac and/or 75 Vdc.

EUROPEAN DIRECTIVE FOR ELECTROMAGNETIC COMPATIBILITY D89/336/CEE AMENDED BY D93/68/CEE, ACCORDING TO RD1950/1995 (01/12).



Francisco Guàrdia
 Quality Manager
 Barberà del Vallès, 1998

IMMUNITY: EN 50082-1 (1992)
 CEI 801-2: UNE 20801-2-94 (Nivel 2)
 CEI 801-3: UNE 20801-3-94 (Nivel 3)
 CEI 801-4: UNE 20801-4-94 (Nivel 3)
EMISSION: UNE 50081-1 (1992)
 EN 55022: Clase B/CISPR 22

EN 60204-1 and prEN 60204-1 CHAP. 12, 13 Electrical security prescriptions.
UNE 21352-76: CEI 359-71 Operating quality expressions for electronic equipments.
UNE 20652-80: CEI 284-68 Behaviour rules inherent to the handling of electronic equipments and other similar technics.

13.- WARRANTY

FEMA ELECTRÓNICA, S.A. warrants this product free of defects in workmanship for ONE (1) year from the date of shipment. This Warranty is VOID if the unit shows evidence of damages as a result of misapplication, accident, misuse or if the product had been tampered or repaired by personnel or companies without the official authorization of **FEMA ELECTRÓNICA, S.A.** This Warranty is VOID also for damages caused by defective or inappropriate applications. In case of malfunction return the unit to the manufacturer for evaluation. Within the warranty period, and after examination, and if the unit is found to be defective and covered by this warranty, the unit will be repaired or replaced.

LIMITATION OF LIABILITY : **FEMA ELECTRÓNICA, S.A.** shall not be responsible for any damage or loss to other equipment however caused, which may be experienced as a result of the installation or use of this product. The liability shall not exceed the purchase price paid of the product upon which liability is based. In no event shall **FEMA ELECTRÓNICA, S.A.** be liable for consequential, incidental or special damages.

SHIPMENTS FOR REPAIR.- Send free of charges and appropriately packed, to the following address :

FEMA ELECTRÓNICA, S.A.
 REPAIRS
 Pol.Ind.Santiga (Altimira 14, Talleres 14, Nave 2)
 Apartado de Correos 49
 E-08210 BARBERÀ DEL VALLÈS (ESPAÑA)

INCLUDE THE FOLLOWING INFORMATION.-

Serial Number : _____
 Signal Input / Signal Output: _____
 Power Supply : _____
 Provided by: _____
 Description of defective encountered :