



Main applications

- Plastics extrusion lines and injection moulding machines
- Polymerization plant for synthetic fibre production
- Rubber moulding machinery
- Driers for ceramics and components for the building industries
- Chemical and pharmaceutical industries
- Industrial electric furnaces
- Food processing plants

Main features

- Command input from analogue voltage or current signal or potentiometer.
- Switching at voltage zero crossing.
- Partialization of wave train power with dynamically optimized time cycle.
- Antiparallel double SCR
- 2 led for supply indication, "ON" state, 1 optional LED for load interrupt alarm
- 4000V isolation between input circuit and power output
- MOV (varistor)
- Optional monitoring of interrupted load

PROFILE

The GT family of solid-state relays has been designed with the aim of providing very accurate control of the load thanks to an analog control input, in voltage at 0...5V; 0...10V or in current at 0...20/4...20mA or a potentiometer (from 1K Ω to 10 K Ω).

The electronic design ensures that the cycle time for proportioning the power is automatically optimized.

Il numero di periodi che il GT fornisce al carico ("treni d' onda") per un certo valore di segnale di ingresso, è calcolato in modo da essere il minimo possibile, pur mantenendo la precisione necessaria.

The number of cycles that the GT supplies to the load (wave trains) for a given input signal is calculated to be the minimum possible to maintain the necessary accuracy.

The GT can be used in three phase systems, using master-slave control architecture in which the control signal drives only one GT (master) and this unit supplies the synchronized signals to the other slaves. Two GS modules can also be used as slaves (logic control).

A load interrupt control option (HB) is available without having to use an external current transformer; alarm limit

is settable with trimmer and yellow LED signal, with voltage-free contact, normally open.

The GT solid-state relay has a green LED to indicate the presence of the 24Vac power supply and a red LED to indicate the switching based on the analog control input signal.

The LED signal will be continuous (off at minimum, on at maximum) at the ends of the scale, pulsing for intermediate values.

The units offer optional accessories for panel mounting, fuses and fuseholders, current transformer, isolation transformers.

Use the relè with an opportune heatsink (see section accessories).

TECHNICAL DATA

General features

Category of use AC1
 Nominal voltage
 - 480Vac (max. range 24...530Vac)
 Nominal frequency: 50/60Hz
 Non-repetitive voltage: 1200Vp
 Zero switching voltage: \leq 20V
 Voltage drop at nominal current \leq 1.4Vrms
 Power factor = 1

Control inputs

Voltage: 0...5Vdc, 0...10Vdc (impedance \geq 100K Ω)
 Current: 0...20mA, 4...20mA (impedance 125 Ω)
 Potentiometer: da1K a 10K Ω (auto-fed by GT)

OUTPUTS

GT 25 (SCR version)

Nominal currents of the device with opportune heatsink in continuous work: 25A
 Non-repetitive overcurrent t=20 ms: 400A
 I 2 t for blowout: \leq 645A 2 s
 dV/dt critical with output deactivated: 1000V/ μ s

GT 40 (SCR version)

Nominal currents of the device with opportune heatsink in continuous work: 40A

Non-repetitive overcurrent $t=20$ ms: 600A
 I^2t for blowout: $\leq 1010A^2s$
dV/dt critical with output deactivated:
1000V/ μs

GT 50 (SCR version)

Nominal currents of the device with
opportune heatsink in continuous work:
50A
Non-repetitive overcurrent $t=20$ ms: 1150A
 I^2t for blowout: $\leq 6600A^2s$
dV/dt critical with output deactivated:
1000V/ μs

GT 60 (SCR version)

Nominal currents of the device with
opportune heatsink in continuous work:
60A
Non-repetitive overcurrent $t=20$ ms: 1150A
 I^2t for blowout: $\leq 6600A^2s$
dV/dt critical with output deactivated:
1000V/ μs

GT 75 (SCR version)

Nominal currents of the device with
opportune heatsink in continuous work:
75A
Non-repetitive overcurrent $t=20$ ms: 1300A
 I^2t for blowout: $\leq 8000A^2s$
dV/dt critical with output deactivated:
1000V/ μs

GT 90 (SCR version)

Nominal currents of the device with
opportune heatsink in continuous work:
90A
Non-repetitive overcurrent $t=20$ ms: 1500A
 I^2t for blowout: $\leq 11200A^2s$
dV/dt critical with output deactivated:
1000V/ μs

GT 120 (SCR version)

Nominal currents of the device with
opportune heatsink in continuous work:
120A (complete with fan and standard
thermostat).
Non-repetitive overcurrent $t=20$ ms: 1500A
 I^2t for blowout: $\leq 11200A^2s$
dV/dt critical with output deactivated:
1000V/ μs

Isolation

Rated isolation voltage input/output:
4000Vac

Power supply:

24Vac $\pm 10\%$, 50/60 Hz
Absorption: 1.5VA
Max. isolation voltage: 300Vdc

Options:

Interrupted HB load alarm.
Controls the load by measuring current
on a shunt inside the device.
The alarm limit is set with a multirev
monorev trimmer.
The alarm output is obtained by means of
a solid state relay.
The contact is normally open (max. 30V,
150mA, conduction resistance 15 Ω).

Thermal features

GT 25

Junction temperature: $\leq 125^\circ C$
Rth junction/case: ≤ 1.25 K/W
Rth junction/ambient: ≤ 12 K/W

GT 40

Junction temperature: $\leq 125^\circ C$
Rth junction/case: ≤ 0.65 K/W
Rth junction/ambient: ≤ 12 K/W

GT 50

Junction temperature: $\leq 125^\circ C$
Rth junction/case: ≤ 0.35 K/W
Rth junction/ambient: ≤ 12 K/W

GT 60

Junction temperature: $\leq 125^\circ C$
Rth junction/case: ≤ 0.35 K/W
Rth junction/ambient: ≤ 12 K/W

GT 75

Junction temperature: $\leq 125^\circ C$
Rth junction/case: ≤ 0.3 K/W
Rth junction/ambient: ≤ 12 K/W

GT 90

Junction temperature: $\leq 125^\circ C$
Rth junction/case: ≤ 0.3 K/W
Rth junction/ambient: ≤ 12 K/W

GT 120

Junction temperature: $\leq 125^\circ C$
Rth junction/case: ≤ 0.25 K/W
Rth junction/ambient: ≤ 12 K/W

Solid State Relay Dissipated Power Calculation

Singol-phase static relay
 $P_{ds} = 1.4 * I_{RMS}$ [W]
 I_{RMS} = singol phase load current

Heatsink thermal resistance Calculation

$R_{th} = (90^\circ C - T_{amb. max}) / P_d$
where P_d = dissipated power
 $T_{amb. max}$ = max air temperature inside
the electrical cabinet.
Use a heatsink with thermal resistance
inferior to the calculated one (R_{th}).

Ambient conditions

- **Working temperature:** 0 to 80°C.
- **Max. relative humidity:** 50% at 40°C
- **Max. installation altitude:**
2000m asl
- **Pollution level:** 2
- **Storage temperature:** -20..85°C

Installation notes

- The heat sink must be grounded.
 - The device must be protected by an appropriate high-speed fuse (accessory).
 - Applications with solid state power units must also include an automatic safety switch to cut out the load power line.
 - Protect the solid state relay by using an appropriate heat sink (accessory).
- The heat sink must be sized according to room temperature and load current (see the technical documentation).
- Procedure for mounting on heat sink:

The module-heat sink contact surface must have a maximum planarity error of 0.05mm. and maximum roughness of 0.02mm. The fastening holes on the heat sink must be threaded and countersunk. Attention: spread 1 gram of thermoconductive silicone (we recommend DOW CORNING 340 HeatSink) on the dissipative metal surface of the module. The surfaces must be clean and there must be no impurities in the thermoconductive paste. Alternately tighten the two fastening screws until reaching a torque of 0.60 Nm for the M4 screws and 0.75 Nm for the M5 screws. Wait 30 minutes for any excess paste to drain. Alternately tighten the two fastening screws until reaching a torque of 1.2 Nm for the M4 screws and 1.5 Nm for the M5 screws. We advise you to randomly check for proper installation by dismantling the module to make sure there are no air bubbles under the copper plate.

Limits of use

- dissipation of thermal power of device with restrictions on temperature of installation site.
- requires exchange with outside air or an air conditioner to transfer dissipated power outside the panel.
- installation restrictions (distances between devices to guarantee dissipation by natural convection).
- max. voltage limits and derivative of transients in line, for which the solid state unit has internal protection devices (depending on model).
- presence of dispersion current
< 3mA for SCR version GS
< 4mA for TRIAC version GS
(max. value with rated voltage and junction temperature of 125°C).

“Zero crossing” with variable cycle time

Examples of the operation of the GT for different values of the input drive signal and the consequent different cycle times (100msec and 40msec respectively).

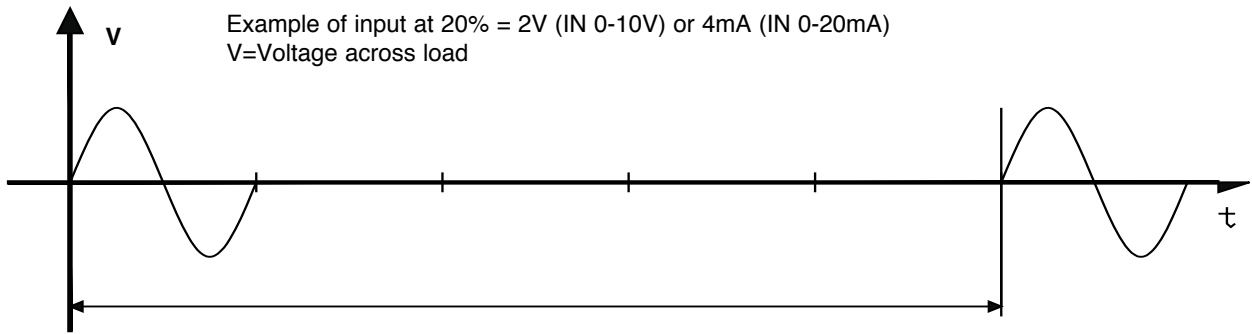

Logic output control for GT

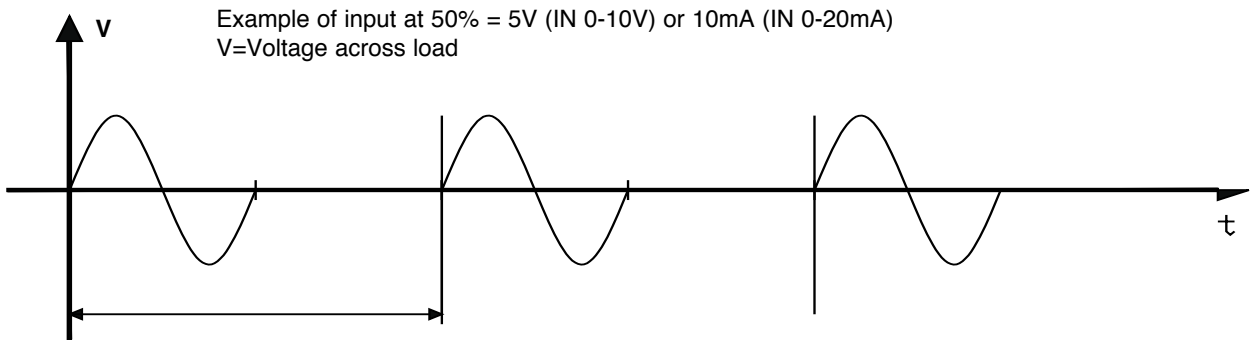

GT thermal protection

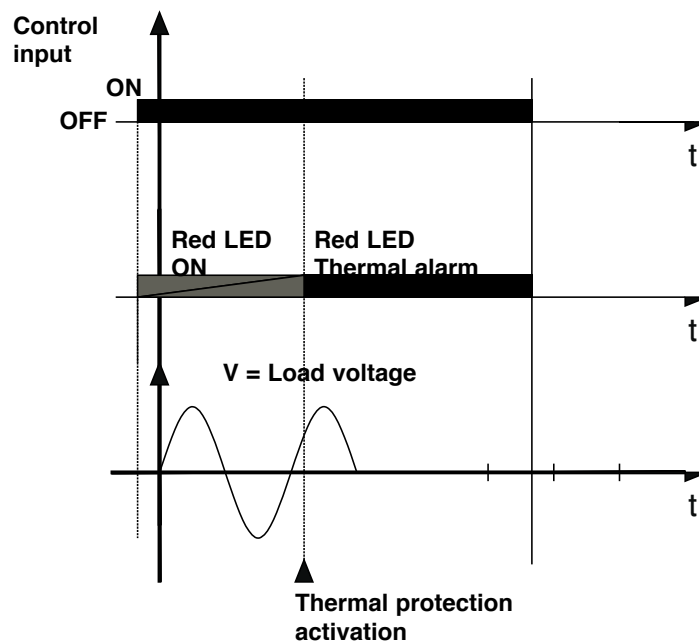

FACEPLATE DESCRIPTION

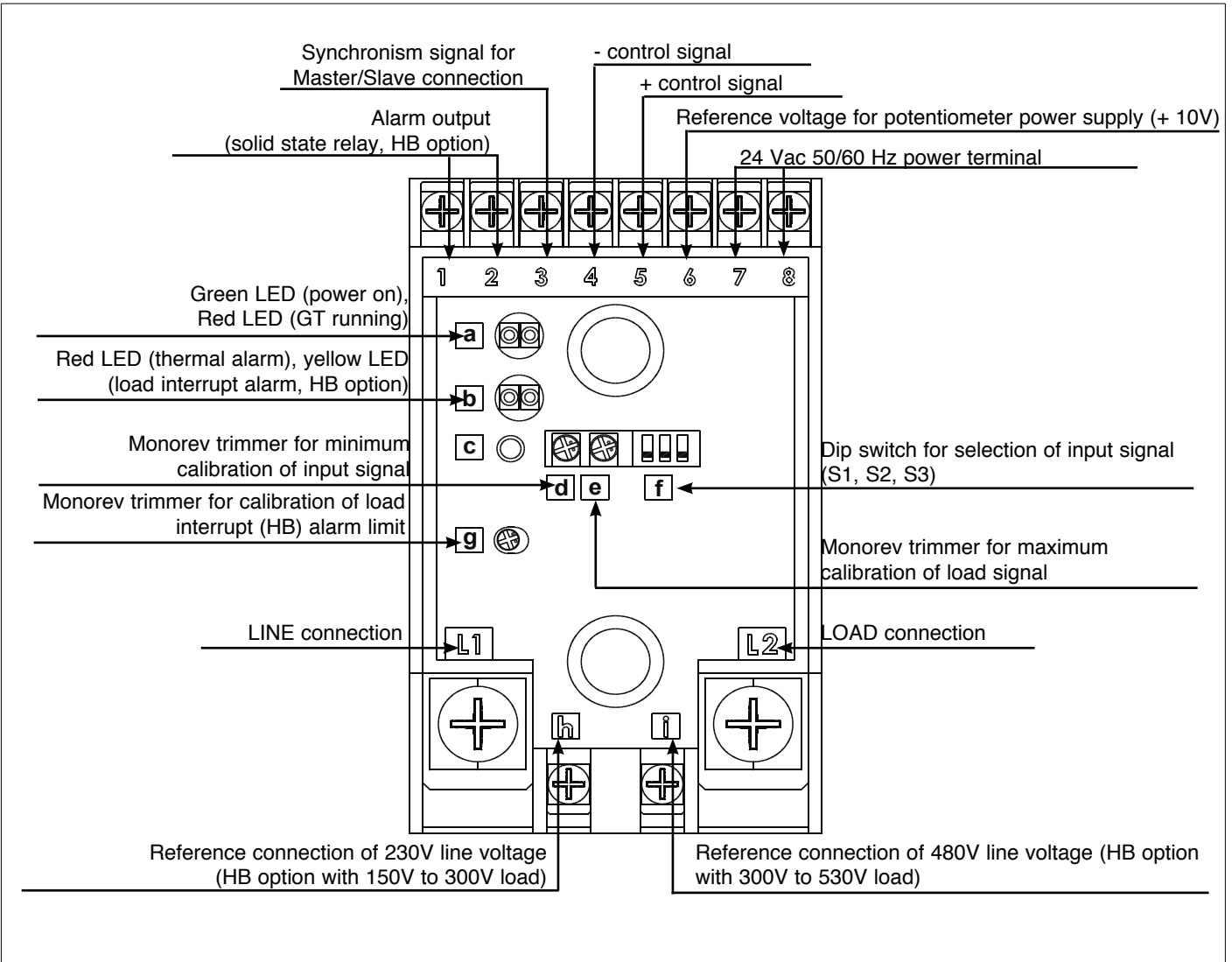

CALIBRATION PROCEDURE OF THE INPUT SIGNAL

The solid-state power unit, Gt, is supplied factory calibrated for 0..5V, 0..10V, 0..20mA, 4..20mA, 10Kohm potentiometer. Minimum and maximum values are adjusted with two monorev trimmers (d,e). Input signal type is selected with the adjustment f dip switches (S1,S2,S3).

Control signal	Dip Switch Position			e		V/mA I_n ---	f	Rin
	S1	S2	S3					
0...5Vdc	OFF	OFF	ON	d 18% 4%			On 0-5V	100K \square
0...10Vdc	ON	OFF	ON				0-10V	100K \square
0...20mA	OFF	ON	ON				0-20mA	125 \square
4...20mA	OFF	ON	OFF				4-20mA	125 \square

Minimum adjustment trimmer (d) turned fully counterclockwise sets the start conducting limit at 4% of the signal; turned fully clockwise, the minimum conducting limit is set at 18% of the input signal.

Maximum adjustment trimmer (e) turned fully clockwise sets the full conducting limit at 96% of the signal; turned fully counterclockwise, the full conducting limit is set at 82% of the input signal.

CALIBRATION PROCEDURE OF THE INTERRUPTED LOAD ALARM

The interrupted load alarm function enables the GT to diagnose a variation of the load current (compared to a set limit), distinguishing it from one caused by a change in grid voltage. The solid state power unit must therefore be supplied with the voltage applied to the load terminals, i.e.: LOAD (L2): already connected internally;
LINE (**h** or **i**): connect terminal **h** for voltages from 150 to 300V; connect terminal **i** for voltages from 300 to 530V.
The alarm activates (relay closed and yellow alarm LED on) when the current, during the conduction of the device, falls below a preset level that may be adjusted using the trimmer on the faceplate.

Calibration procedure (refer to the faceplate description drawing)

- 1) Use the adjustment system (or a calibrator) in order to supply the maximum signal (100% conduction or the red "ON" LED always illuminated). As an alternative, you can configure the GT to 0-10 V DC input configuration and connect terminals 5 and 6.
- 2) Use a current sensing pliers to check that the load current is at rated level.
- 3) Turn alarm limit adjustment trimmer (g) fully clockwise. Check that yellow alarm LED (b) turns on.
- 4) Slowly turn trimmer (g) counterclockwise until the alarm LED turns off.
- 5) Turn the trimmer counterclockwise another 1/10 of a turn (1 notch on the scale).
In this way, the alarm limit is set below 10% of the rated load current.

N.B:

the partial load break alarm function operates with power partialization exceeding 15%. For partializations below 20%, tripping times increase due to the reduced load activation time. For correct operation of the option, the load current has to exceed 30% of rated current for the GT.

Notes on use of the GT with the digital On/Off control

- The logic control signal has to be connected with the correct polarities to terminals 4 and 5 of the analog input.
- Turn minimum adjustment trimmer (d) fully counterclockwise and maximum adjustment trimmer (e) fully clockwise.
- Set the 3 dip switches (f) to off.

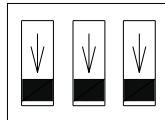

For applications with a very short work cycle, you can drive the solid state group by means of the Master/Slave signal by driving it with a digital signal (OFF = 0 V dc; ON = from 4 V dc to 10 V dc)

Inhibiting the GT

You can inhibit operation of the GT by means of the Master/Slave signal.
To inhibit, connect control signal - (4) with the synchronism signal for Master/Slave connection (3).

Notes on use of the GT in Master/Slave configuration

The GT can be used as a master to drive other solid state groups (slaves). With Master/Slave signal (3), you can drive up to 9 GTs (see connection examples for GT solid state power relays with three-phase load). You can also use a GT to drive GS solid state power relays (maximum of 2), as shown in the connection diagrams for GT/GS solid state power relays with three-phase load (attention: the HB option cannot be used for a three-phase application with neutral).

CONNECTION EXAMPLES

Star or delta three-phase connection without neutral, with control of two phases.

- * Connections regarding the load interrupted option (see paragraph "Interrupted load alarm")
- Note: connect **h** or **i** according to the load tension.

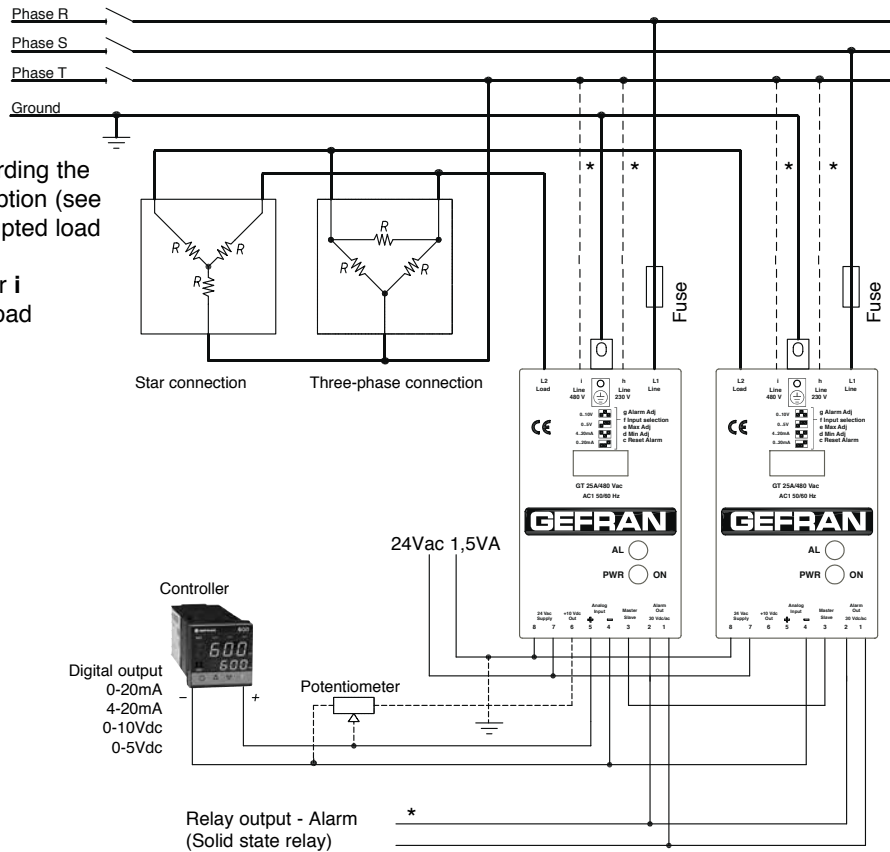

Star or delta three-phase connection without neutral, with control of three phases.

- * Connections regarding the load interrupted option (see paragraph "Interrupted load alarm")
- Note: connect **h** or **i** according to the load tension.

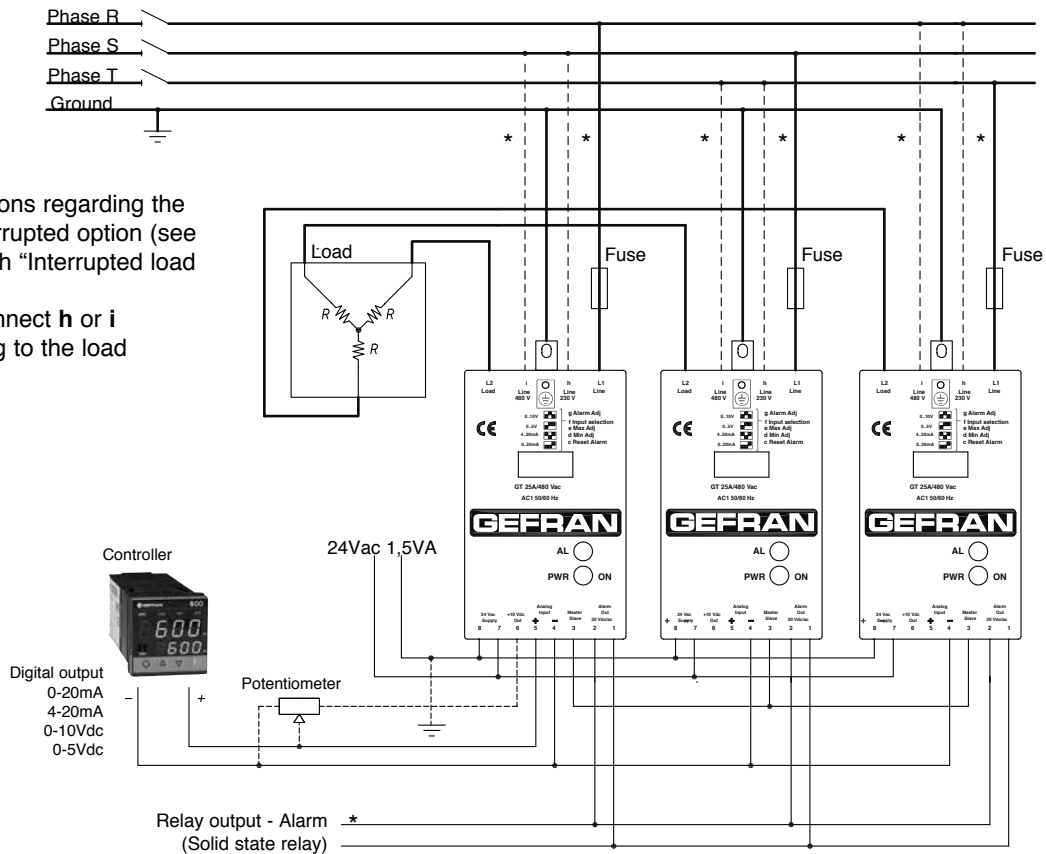

CONNECTION EXAMPLES

Three-phase star connection with neutral.

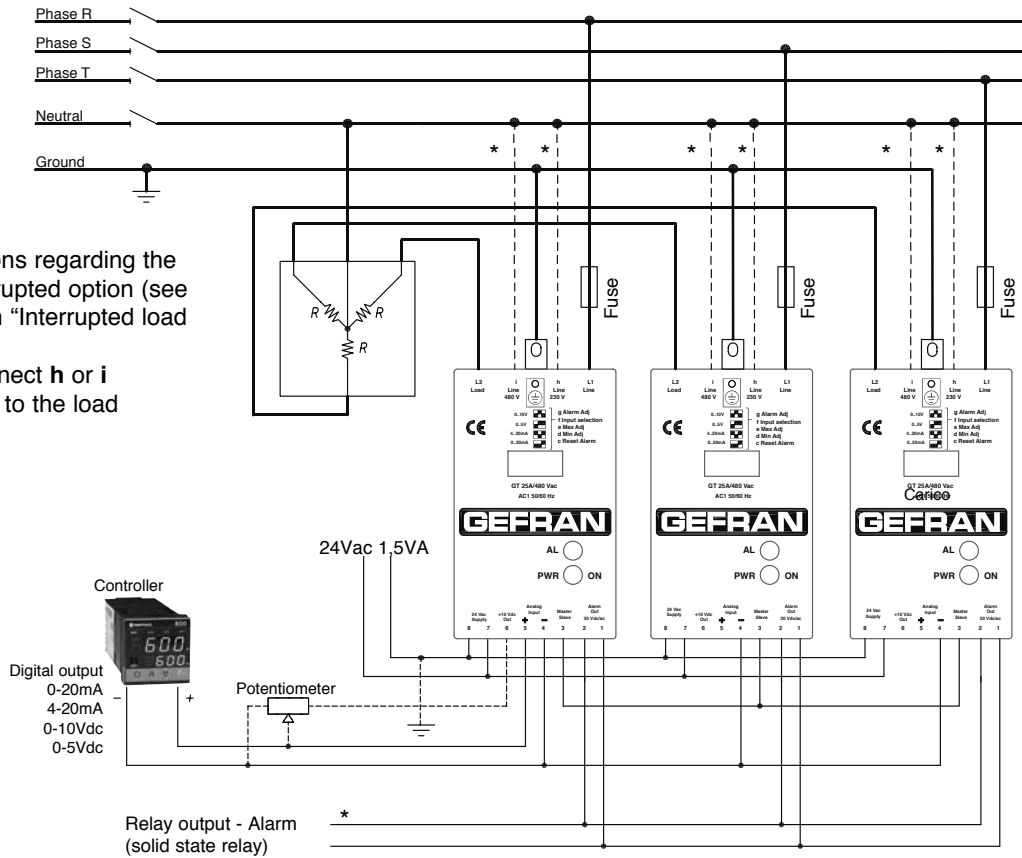

Three-phase connection (triangle or star) without neutral, with control of two phases using one GT in Master configuration and one GS in Slave configuration.

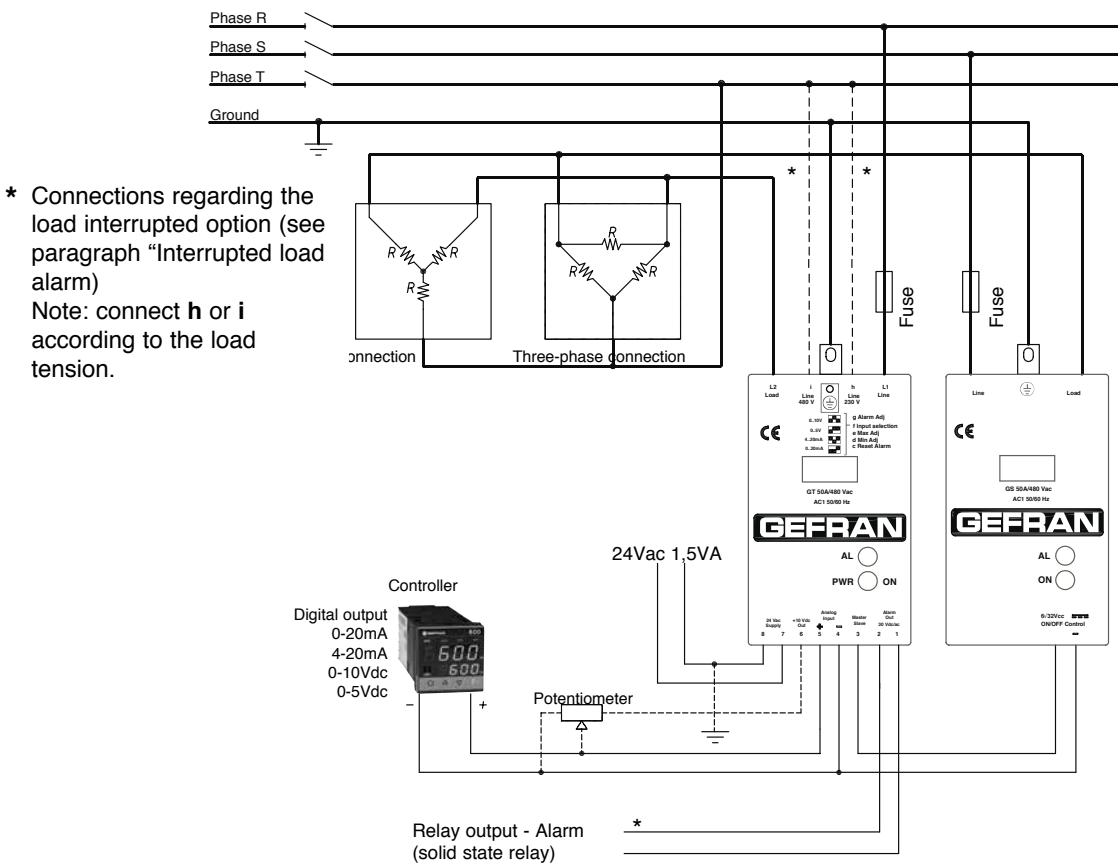

CONNECTION EXAMPLES

Three-phase star connection with neutral using one GT in Master configuration and two GSs in Slave configuration.

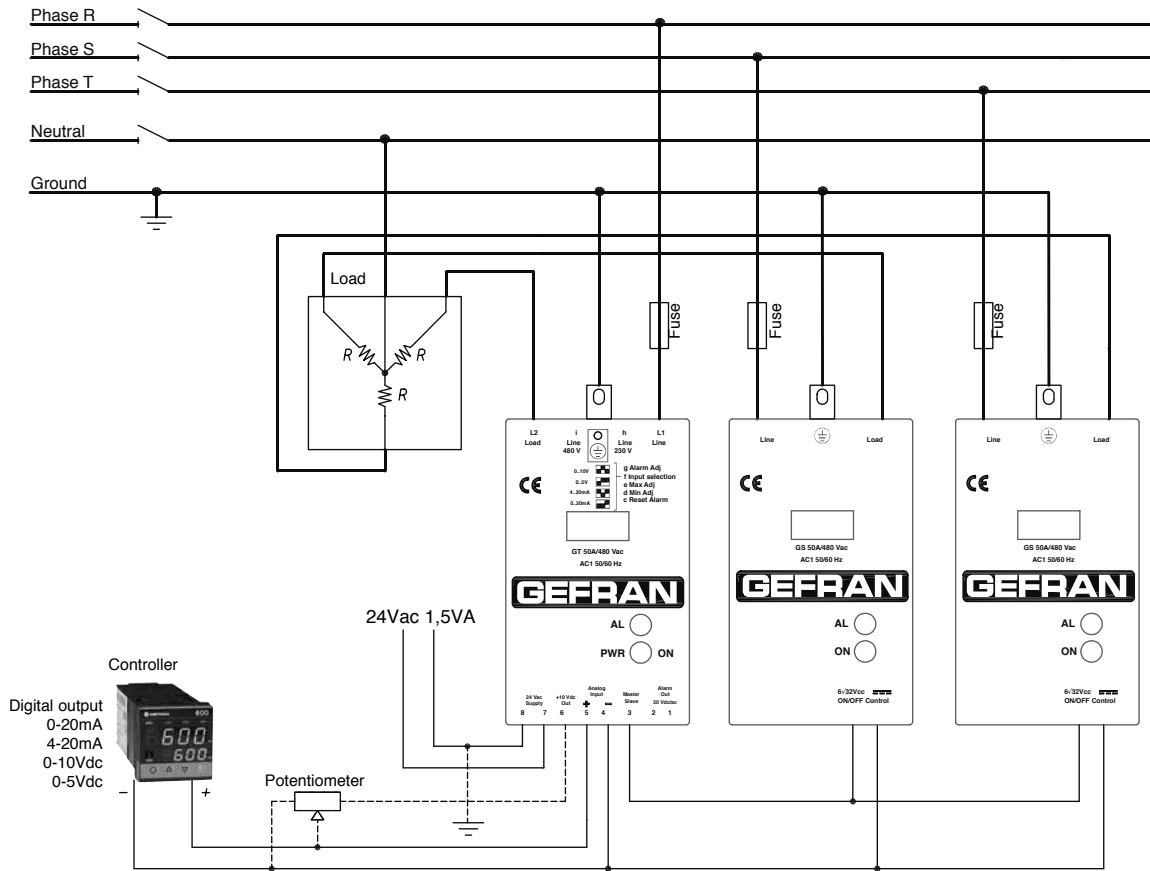

TABLE OF TERMINALS AND CONDUCTORS

Size	CONTROL TERMINAL			POWER TERMINAL			GROUND TERMINAL •	
	Contact area (WxD) screw type	Type of pre-isolated terminal	Max section. ** conductor tightening torque	Contact area (WxD) screw type	Type of pre-isolated terminal	Max section. ** conductor tightening torque	Contact area (WxD) screw type	Max section. ** conductor tightening torque
25/40A 50/60A	6,3x9 M3	Eye/fork / tip	2.5mm ² 0.6Nm Max	16x18 M6	Eye/fork	50mm ² 3.5-6 Nm	14x16 M5	50mm ² 1.8-2.5Nm
75-90A	6,3x9 M3	Eye/fork / tip	2.5mm ² 0.6Nm Max	16x18 M6	Eye/fork	50mm ² 3.5-6 Nm	14x16 M5	50mm ² 1.8-2.5 Nm
120A	6,3x9 M3	Eye/fork / tip	2.5mm ² 0.6Nm Max	16x18 M6	Eye/fork	50mm ² 3.5-6 Nm	14x16 M5	50mm ² 1.8-2.5 Nm

(**) The max. sections specified refer to unipolar copper wires isolated in PVC.

- Note: For the ground terminal, you have to use an eye wire terminal.
(WxD) = Width x depth

ACCESSORIES

A wide range of accessories is available (including fuses and fuse holders, supports for fastening DIN bar, ID plates, thermostats, current transformers and isolation transformers). To choose accessories, see the section "Solid state relays - Accessories."

ORDER CODE

	GT	/	480	-	
Model	GT				
Nominal current					
25Aac	25				
40Aac	40				
50Aac	50				
60Aac	60				
75Aac	75				
90Aac	90				
120Aac	120				
Nominal voltage					
480Vac	480				
Load interrupt (HB) option					
Without option	0				
With load interrupt option	1				

Please contact GEFTRAN personnel for information on availability of codes.

•WARNINGS

WARNING: this symbol indicates danger.

Before installation, please read the following advices:

- follow the indications of the manual scrupulously when making the connections to the instrument.
- use a cable that is suitable for the ratings of voltage and current indicated in the technical specifications.
- if the instrument is used in applications where there is risk of injury to persons and damage to machines or materials, it is essential that it is used with an auxiliary alarm device.

It is advisable to verify frequently that the alarm device is functional even during the normal operation of the equipment.

- The instrument must NOT be used in environments where there could be the presence of dangerous atmospheres (inflammable or explosive).
- During continuous operation, the heatsink may reach 100°C and remain at a high temperature due to thermal inertia even after the device is switched off. Therefore, DO NOT touch the heat sink or the electrical wires.
- do not operate on the power circuit unless the main supply is disconnected.
- DO NOT open the cover if device is "ON"!
(use the holes in the cover for eventual re-calibration).

Installation:

- connect the device to the ground using the proper ground terminal.
- the power supply wiring must be kept separate from that of inputs and outputs of the instrument; always check that the supply voltage corresponds to that indicated on the instrument cover.
- evitare la polvere, l'umidità, i gas corrosivi, le fonti di calore.
- keep away from dust, humidity, corrosive gases and heat sources.
- The connection cable must be shorter than 3 meters if the current transformer is used.

Maintenance: Check the correct operation of the cooling fans at regular intervals; clean the ventilation air filters of the installation at regular intervals.

- Repairs must be performed only by specialized or appropriately trained personnel. Cut off power to the device before accessing internal parts.
- Do not clean the box with solvents derived from hydrocarbons (trichloroethylene, gasoline, etc.). Using such solvents will compromise the mechanical reliability of the device. To clean external plastic parts, use a clean cloth wet with ethyl alcohol or water.

Technical service : GEFTRAN has a technical service department. Defects caused by use not conforming to the instructions are excluded from the warranty.

GEFRAN spa reserves the right to make any kind of design or functional modification at any moment without prior notice



This device conforms to European Union Directive 2004/108/CE and 2006/95/CE as amended with reference to generic standards: **EN 61000-6-2** (immunity in industrial environment) **EN 61000-6-4** (emission in industrial environment) - **EN 61010-1** (safety regulations).



In Conformity with **UL508 - File: E243386**