

ISOTECH

✓ The Source for Calibration Professionals

Portable Dry Blocks, Liquid Baths and Multi-functional Heat Sources



The **ADVANCED**, **BASIC** & **SITE** Range
of Portable Temperature Calibrators

Contents

A Guide to the three versions - Basic, Site & Advanced	4
A Guide to the ISOCAL-6	6 - 7
Hyperion and Drago -25°C to 250°C 65mm Calibration Volume	8 - 11
Europa, Venus and Calisto -45°C to 250°C 35mm Calibration Volume	12 - 15
A Guide to Dry Blocks	16 - 17
Jupiter 35°C to 660°C 35mm Calibration Volume	18 - 21
Gemini 35°C to 700°C 65mm Calibration Volume	22 - 25
Pegasus 150°C to 1200°C 33.5mm Calibration Volume	26 - 29

A Guide to **Traceable Calibration**

For best practice, the thermometer (or thermometers) under test are placed into the calibration volume alongside a calibrated standard. This is so that the test thermometers “can be related to appropriate standards, generally international or national standards, through an unbroken chain of comparisons”. This “traceability” meets the requirements of quality systems including that of ISO 9000.

Using the Calibrator itself as the Reference (or standard) raises a number of issues, such as how is temperature difference between the test thermometer and the calibrator display determined - how can this ‘uncertainty value’ be known?

International Guidelines have been published from EURAMET that give guidance, and requirements, for the calibration of Dry Blocks EURAMET/cg-13/v.01 (formerly EA10-13) and Isotech Calibrators meet the calibration capacity requirements of EURAMET/cg-13/v.01.

We recommend that a reference probe is used, the same method as used in secondary temperature laboratories. For less demanding calibration, and the quick testing of sensors, the Calibrator can be used without a reference probe, refer to the units Evaluation Report for typical performance data.



The company is always willing to give technical advice and assistance where appropriate. Equally because of the programme of continual development and improvement, we reserve the right to amend or alter characteristics and design without prior notice. This publication is for information only.

Alternative methods of using Isotech Portable Calibrators

■ A Basic Dry Block Calibrator

The thermometer under test is compared to the dry block controller value.
Useful for moderate temperature ranges and quick testing.



A control system with digital display shows the set and measured value from the calibration volume.

■ An ISO 9000 Calibration System

A thermometer under test is compared to a calibrated standard,
for true traceability and clearly meets the requirements of ISO9000

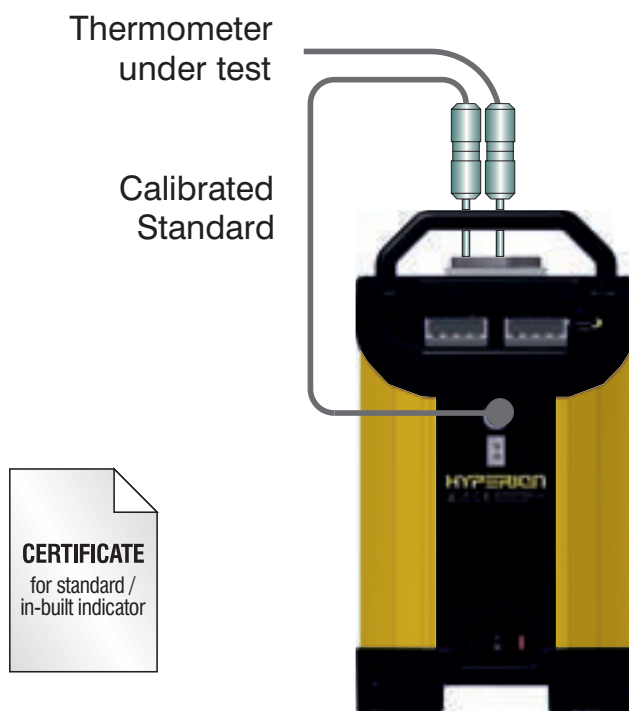

In addition to the temperature control system with its display the Isotech SITE model includes a separate temperature read out for the Standard (Reference) probe.

■ Isotech ADVANCED Calibrator

Isotech ADVANCED models have inputs for both the test thermometer and a calibrated standard.

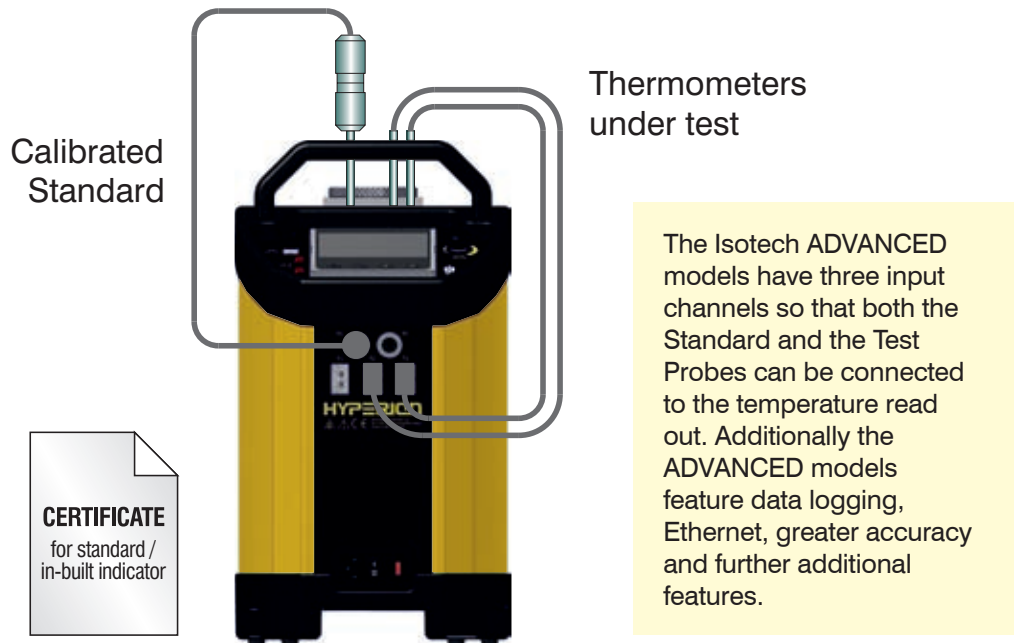

■ Using an External Indicator

Similar to the previous configuration but an external indicator is used - one instrument can be used with many calibration baths - the bath or baths do not need a calibration certificate, but they need an evaluation report.

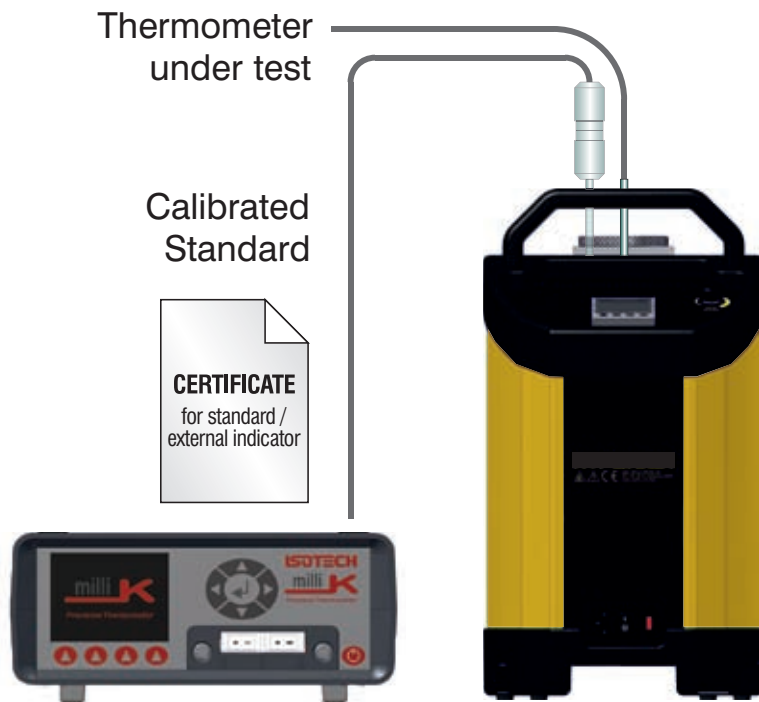

■ An example of Multiple Sensor Calibration

You can add a scanner for multi-probe calibration - the system can then be automated.

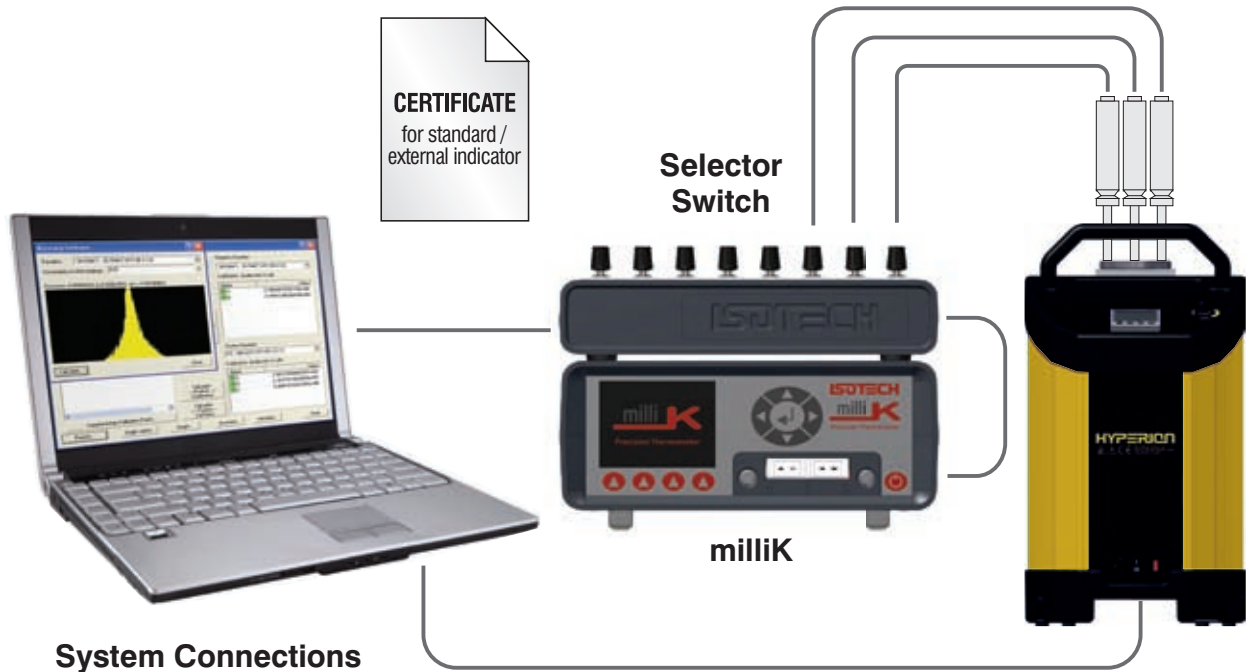

System Connections

Isotech - award winning flexible solutions for all sensor types from -45°C to 1200°C

By adding different accessories the 4000 Series can be used in up to six different modes - Dry Blocks, Liquid Baths, Ice Bath, Surface Sensor Calibrator, IR Thermometer Calibrator and even with ITS-90 Fixed Point

	Ø 65mm	Ø 65mm	Ø 35mm	Ø 35mm	Ø 35mm	Ø 65mm	Ø 35mm	Ø 33.5mm
	Isocal-6					Dry Block Calibrators		
	HYPERION	DRAGO	EUROPA	VENUS	CALISTO	GEMINI	JUPITER	PEGASUS
Specifications								
Metal Block Bath	✓	✓	✓	✓	✓	✓	✓	✓
Stirred Liquid Bath	✓	✓	✓	✓	✓			
Stirred Ice/Water Bath	✓		✓	✓				
Blackbody Source	✓	✓	✓	✓	✓	✓	✓	✓
Surface Sensor	✓	✓	✓	✓	✓		✓	
ITS-90 Fixed Point	✓	✓	✓	✓	✓			
Temperature Range (°C)								
1200°								150°C → 1200°C
1100°								
1000°								
900°								
800°								
700°								
600°								
500°								
400°								
300°								
200°								
100°								
0°	-25°C → 140°C	30°C → 250°C	-45°C → 140°C	-35°C → 140°C	30°C → 250°C	35°C → 700°C	35°C → 660°C	
-100°								

Isotech 4000 Series

Available in three different versions

Isotech calibrators are available in three different versions; they all feature the same rugged casing with award winning calibration volumes. The range of features varies with the ADVANCED offering extra performance in terms of resolution and temperature stability. All models have common block sizes, interchangeable options and benefits providing calibration volumes with superior temperature uniformity and capacity for industrial probes.

Choose to suit your application:

MODEL

BASIC

■ Features

- Calibrate the entire loop by using a heat source rather than an electrical simulator, a test instrument and sensor can be calibrated as a system
- Simple To Use and Outstanding Value
- Rugged Case
- Calibrate all Sensor Types
- Ramp to Set Temperature
- Supply Voltage Power Correction and Digital Filtering
- PC Interface and Software



MODEL

SITE

■ Features

As Basic but adds independent temperature indicator for reference probe

- Accepts Platinum Resistance Thermometers, Process Inputs Including 4 - 20mA, Thermocouples including Types K,N,R,S,L,PL2,T,J and E.
- Thermostat Testing, Stand Alone or with PC
- Configurable Units °C, °F or K



ADVANCED

■ Best performance

- Benefit from advanced temperature controller that provides best performance
- Resolution to 0.001°C - Superior Stability
- Control parameters automatically optimised with temperature

■ View easily in all conditions

- Large Bright Colour Display
- Similar to Smartphone
- Crystal clear display with full colour graphics

■ Thermostat testing

- Test Two Thermostats Simultaneously

■ View from anywhere

- 21st Century Connectivity with Ethernet and inbuilt webserver
- Connect to the network and view the calibrator from anywhere, on your Notepad, Tablet or Smartphone



■ Save time and money

AUTOMATIC TEMPERATURE CYCLING

- Program the ADVANCED with the temperature points you need, store commonly used ranges. The calibrator can then automatically follow these points and log your data

■ Safely store and secure all the data you need

- Massive Internal Memory can safely store all your data
- Store a lifetime of data on a USB Drive
- Choose Open CSV Files or Tamper Proof Data with Secure File Format for Data Security

■ Supports five languages

- English, French, German, Italian and Spanish
- Simple to use with clear user interface

■ Connect more probes

UP TO 3 INPUT CHANNELS

- Inbuilt reference system with two universal inputs for PRT, Thermocouple or Process Input and a third thermocouple input
- Input types: Process Inputs including 4-20mA, PRT, and Thermocouple Types B, C, D, E, J, K, L, N, R, S, T, U

■ Offset elimination

- Connect a reference probe to one of the external probe inputs and the calibrator can trim the block temperature to remove offsets
- Block adjusted to reference probe value
- Remove offsets
- Use in combination with automatic cycling

■ The software you need

- PC tools for reviewing data with support for secure file format, managing temperature programs, easy configuration and data logging.



Introduction: 4000 Series

The 4000 series includes the Isocal-6 multifunction calibration system

The award winning ISOCAL-6 consists of a range of temperature calibrators designed to calibrate all temperature sensors. As a multi function temperature calibrator it can be used as a Dry Block with accessories added to allow use as a Stirred Liquid Bath, a Blackbody Source, a Surface Temperature Calibrator, an ITS-90 Fixed Point System and for low temperatures a Stirred Ice Bath.

The ISOCAL-6 is a complete temperature calibration laboratory in a simple easy to use package.

A system designed to expand with you, to fulfill all future calibration needs. Giving the flexibility to add accessories when needed and meet current budgetary demands.



1

Metal Block Bath

A Metal Block Bath, (Dry Block Calibrator) provides fast and clean calibration of thermocouples, PRTs and other industrial temperature sensors. Isotech blocks use a combination of multi zone and advanced materials technology to ensure constant temperature zones to enable high accuracy calibration. Interchangeable 35mm diameter blocks allow several sensors to be calibrated simultaneously with fast heat up and cool down. For larger probes blocks are available up to 65mm diameter and with immersion depth of up to 300mm. An unmatched combination of leading performance and calibration capacity.



2

Stirred Liquid Bath

Remove the metal block and the Isocal-6 can be converted to a stirred liquid bath. Liquid bath operation allows angled or awkward shaped probes to be calibrated. Accuracies are improved over Dry Blocks alone and with a suitable reference probe performance of 0.005°C is achievable. In stirred liquid bath mode a reference probe should be used.



3

Stirred Ice / Water Bath

The ISOCAL-6 models that operate below 0°C can be used to provide a 0°C stirred ice / water bath. This provides a simple low cost way of checking that standards have not drifted in between calibrations.



4

Blackbody Source

Adding the blackbody target allows the testing of infrared thermometers. Low cost non-contact IR thermometers are increasingly being used in industry and the ISOCAL-6 is ideal to test and check these devices. The IR thermometer is focused on the target and compared to a reference probe in the block pocket.



5

Surface Sensor Calibrator

With the Surface Sensor Kit the test sensor is compared to a platinum resistance thermometer located just below the surface of the block. Again save the cost of buying additional equipment by adding accessories as required to expand the ISOCAL-6 for new calibration applications.



6

ITS-90 Fixed Point Apparatus

For the best possible performance with uncertainties to 0.0005°C (0.5mK) add an ITS-90 Fixed Point Cell. The most popular is the B8 Water Triple Point Cell, it is surprisingly affordable and simple to use - the triple point can be both created and maintained in the apparatus without the need for any other equipment or supplies.

4000 Series

Calibration Options

Isotech's UKAS accredited calibration laboratory was established in 1980 and has grown to be a full scale laboratory providing calibration to the smallest of uncertainties. Isotech certificates are formally recognised in over 70 countries and carry the ILAC-MRA logo.

We can provide different certificates, reporting the temperature only (UKAS-TEMP), additionally we can include the inbuilt temperature indicator channels calibrating by electrical simulation, (UKAS-SYST) or we can just calibrate the input channels (UKAS-SIM).

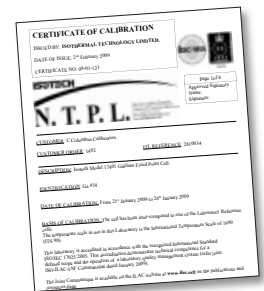

The following Calibration Options are Available		Code
BASIC, SITE and ADVANCED	5 point calibration for block temperature; includes reference probe values when ordered with Site or ADVANCED	UKAS-TEMP
ADVANCED	5 point calibration for block temperature and reference probe (when ordered) and electrical simulation of indicator	UKAS-SYST
ADVANCED	Calibration of input channels, electrical simulation only	UKAS-SIM

Included Software

Model	Software	Connection
BASIC and SITE	Cal Notepad and I-Cal Easy LOG: Log and Monitor Calibrator	Serial
ADVANCED	I-Cal Easy LOG: Log and Monitor Calibrator	Ethernet
ADVANCED	Review Lite: Manage Log Data, supports secure data format	Ethernet
ADVANCED	Set Point Program Editor: Manage ADVANCED set point programs	Ethernet
ADVANCED	Isotech ADVANCED Block Configuration Utility: Fast configuration from a PC	Ethernet

Download: <http://www.isotech.co.uk/downloads>

Isotech Innovation

We have been providing calibration solutions for more than 30 years, from Primary Standards for National Metrology Institutes through to handheld calibrators for service engineers.

Our portable calibrators have set a number of world firsts, the first Dry Blocks to feature an independent inbuilt temperate indicator and the first Dry Blocks to reach -100°C. The award winning ISOCAL-6 was the first calibrator to offer both Dry Block and Liquid Bath use. It remains the only device to offer six modes of calibration.

Isotech Dry Block Range - expanded and upgraded

- New Rugged Lightweight Outer Cases
- Custom moulded components brings lighter and stronger Portable Calibrators
- New ADVANCED model - more features than ever before

The ADVANCED Models include automatic temperature cycling which saves time and money with the calibrator automatically logging data over a series of calibration points



Temperature Cycling and Logging

Features of the ADVANCED models

Automatic Temperature Cycling

- Save Time
- Save Money
- Store up to 100 Programs

Calibration temperatures and dwell times can be combined into 'programs' for the ADVANCED calibrator to follow, up to 100 programs can be stored, with each program having up to 25 segments.

Programs can be edited from the front panel or on a PC with Set Point Program Editor.

As the program runs all measurements are recorded to the large internal memory.

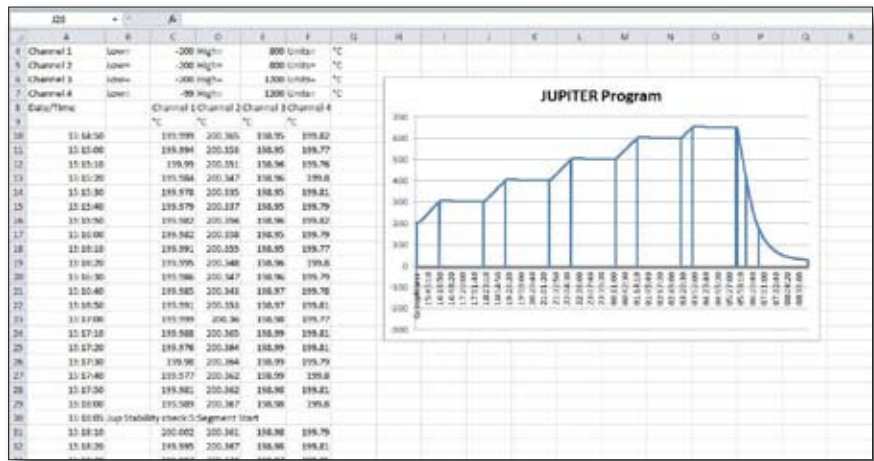

Automatic temperature cycling saves time and money with the calibrator automatically logging data over a series of calibration points

Data Logging

- Large Internal Memory to Store Your Data
- Creates CSV Files For Spreadsheets
- Creates Secure Tamper Proof Data to aid compliance to standards

The ADVANCED models log data to internal memory, the data is logged in a CSV format that can readily be opened and edited.

Data is also recorded in a secure tamper proof format as a binary 'UUH File'. These files can be opened with Review Lite software – download from our website. If the records

are found to have been tampered with then Review Lite will reject the record as corrupt.

Data files can be shared automatically across the network via FTP, transferred manually via USB or 'pulled' into Review's database.

For users working in regulated industries these features, when used in conjunction with company procedures and other equipment or process, aids compliance to standards such as FDA, 21 CFR 11 and AMS2750E.

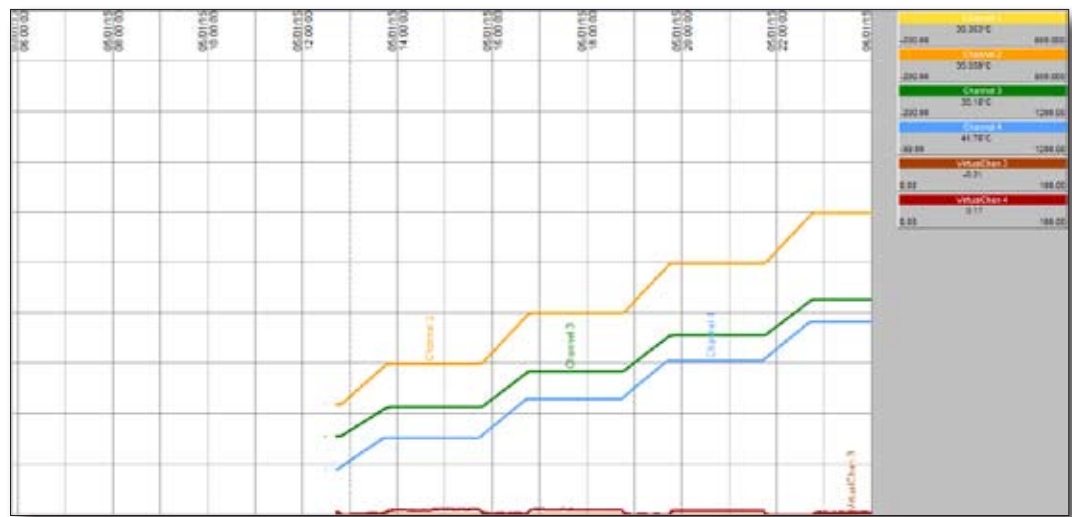

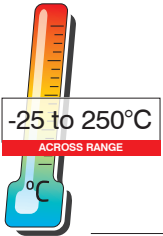

ISOCAL - 6 Range Hyperion • Drago

- Multi Function: Six Modes including Dry Block and Liquid Bath
- 65mm Volume: Ideal Liquid Bath
- Calibrate entire measurement loop - using a heat source rather than an electrical simulator, a test instrument and sensor can be calibrated as a system

The Hyperion and Drago have large calibration volumes, 65mm x 160mm deep, which makes them ideal to use as portable liquid baths. Stirred liquid baths are suitable for temperature sensors of all types, sizes and shapes. Liquid Baths can provide smaller calibration uncertainties than dry blocks and when used with suitable reference thermometers, accuracies of up to 0.005°C can be achieved.

These models are part of the award winning Isocal-6 family and with a reference probe can be used with different accessories for Dry Block, Infrared, Surface Calibration and even with ITS-90 Fixed Point Cells for uncertainties to 0.001°C. In Dry Block Mode, the large 65mm diameter block allows for the calibration of either larger probes or for calibrating many sensors simultaneously.

As a Liquid bath the sensors can be placed directly into the stirred liquid thus avoiding the need for specially drilled blocks. If the liquid is directly in the block then the controller only model, or Basic (B) model, can be selected. However, instead of putting liquids directly in the block liquid containers can be used to facilitate rapid change of fluids. For greater accuracy, or when using a liquid container, Dry Block Insert, Blackbody Target or the Surface Sensor Kit a separate reference thermometer should be used to compensate for the varying offset between the controller and the accessory temperature.

An ideal arrangement would be to include the handheld Isotech TTI-10 or the bench top Isotech milliK Precision Thermometer and Model 935-14-16 Semi Standard Platinum Resistance Thermometer.



<http://www.isotech.co.uk/industrial/>

Alternatively the SITE or ADVANCED model can be selected; the SITE includes a temperature indicator for a reference probe. The ADVANCED also includes inputs for test thermometers, automatic temperature cycling, logging and additional sophisticated features.

All models include I-Cal Easy LOG software and the ADVANCED models additionally include software to manage logged data and configure the unit, see page 10 for more details.



PARAMETER	Model	
	Hyperion 4936	Drago 4934
Temperature Range	-25°C to 140°C ¹	30°C to 250°C ²
ADVANCED Range		
Stability: Dry Block / Liquid Bath	±0.005°C	±0.005°C
Display Resolution	0.001°C over whole range	0.001°C over whole range
Accuracy: RTD Input Channels	±0.05°C ±0.005% RDG	
Accuracy: Thermocouple Input Channels	E,J,K,N: ±0.2°C @ 660°C R: ±0.6°C S: ±0.7°C @ 660°C T ±0.2°C @ 150°C	
CJC Accuracy	±0.35°C	
BASIC / SITE Range		
Stability	±0.03°C	±0.03°C
Display Resolution	0.01°C from -19.99 to 99.99°C then 0.1C: 0.01°C Over PC Interface	
COMMON Specifications		
Stability	Blackbody ±0.3°C Surface Sensor ±0.5°C ITS-90 Cells ±0.0005°C	
Display Accuracy ³	0.15°C	0.15°C
Uniformity - Radial, Liquid Bath Mode	<0.009°C	<0.007°C
Uniformity - Axial, Liquid Bath Mode (40mm)	<0.011°C	<0.013°C
Uniformity - Radial, Dry Block Mode (Between Wells)	<0.008°C	<0.008°C
Uniformity - Axial, Dry Block Mode (40mm)	<0.040°C	<0.040°C
Heating Time	-20°C to 140°C: 40 Mins	30°C to 250°C: 40 Mins
Cooling Time	140°C to 20°C: 90 Mins 20°C to -25°C: 80 Mins	250°C to 30°C: 90 Mins
Insert Size	65 x 160mm	
Insert Types	Standard 8 x 8mm + 2 x 4.5mm, Undrilled or Custom Drilled	
Power	115 or 230Vac 50/60Hz 200 Watts	115 or 230Vac 50/60Hz 1000 Watts
Dimensions	384H (including handle) x 212W x 312D mm	
Weight	12kg	8kg

(1) In ambient of 20°C: Minimum Temperature is 45°C Below Ambient, Absolute Minimum -35°C

(2) In ambient of 20°C

(3) Dry Block Mode only: Comparing 4.5mm Well to Display Value.

	ADVANCED	SITE	BASIC
Digital Display of Set and Nominal Block Temperature	Yes	Yes	Yes
PC Interface	Ethernet + USB Host	Serial	Serial
Test Thermostats	Yes - Two Inputs	Yes - Single Input	No
Independent Temperature Indicator for Reference Probe	Yes	Yes	No
Additional Inputs for Units Under Test	Up to 3: Two universal inputs for PRT, Thermocouple or Process inputs and a further Thermocouple input	No	No
Automatic Temperature Cycling	Yes	No	No
Data Logging	Yes - Export to USB	No	No
Offset Elimination	Yes - block can follow reference input	No	No
Choose English, French, Italian or Spanish Language	Yes - on full colour display	No	No
In Built Web Server	Yes	No	No
Tamper Proof Data	Yes - Suitable for life science, automotive and aerospace applications	No	No

ISOCAL-6

LIQUID & DRY BLOCK



Metal Block Bath

Dry Block Calibrator provides fast and clean calibration of thermocouples, PRTs and other industrial sensors. Isotech blocks use a combination of multi zone and advanced materials technology to ensure constant temperature zones for high accuracy calibration.



Stirred Liquid Bath

Remove the metal block to convert to a stirred liquid bath. Liquid bath operation allows angled or awkward shaped probes to be calibrated. Accuracies are improved over Dry Blocks alone and with a suitable reference probe performance of 0.005°C is achievable.

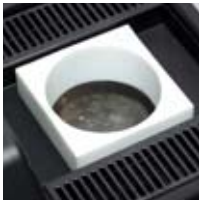

Stirred Ice / Water Bath

The ISOCAL-6 models that operate below 0°C can be used to provide a 0°C stirred ice / water bath. This provides a simple low cost way of checking that standards have not drifted in between calibrations.



Blackbody Source

Adding the blackbody target allows the testing of infrared thermometers. Low cost non-contact IR thermometers are increasingly being used in industry and the ISOCAL-6 is ideal to test and check these devices. The IR thermometer is focused on the target and compared to a reference probe in the block pocket.

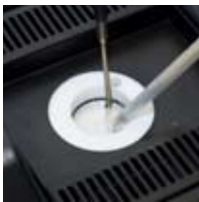

Surface Sensor Calibrator

With the Surface Sensor Kit the test sensor is compared to a platinum resistance thermometer located just below the surface of the block. Again save the cost of buying additional equipment by adding accessories as required to expand the ISOCAL-6 for new calibration applications.



ITS-90 Fixed Point Apparatus

For the best possible performance with uncertainties to 0.0005°C (0.5mK) add an ITS-90 Fixed Point Cell. The most popular is the B8 Water Triple Point Cell, it is surprisingly affordable and simple to use - the triple point can be both created and maintained in the apparatus without the need for any other equipment or supplies.



*World's First
Multi-Functional
Baths
SIX FUNCTIONS*

Hyperion / Drago Accessories

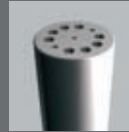

Dry Block Mode with Inserts

936-06-01a Standard Insert is: 8 x 8mm + 2 x 4.5mm all 157mm Deep. All Inserts have a 4mm tapped hole to suit supplied extractor tool.

Alternative Inserts

936-06-01b Blank Insert
936-06-01c Special Insert.



Stirred Liquid Mode with Liquid Container Kit **936-06-02**

Allows liquid bath use, includes container, magnetic stirrer, probe guide and sealing cap.

Stirred Ice Bath Mode with Liquid Container Kit

Uses same liquid kit to provide 0°C reference as a stirred ice bath.



Thermometer Support Kit **936-06-08**

Supports up to eight thermometers into liquid. Suits probes 5mm - 8mm in diameter.

936-06-07	C10 Oil	-35°C – 140°C	1L
580-06-09	C20 Oil	20°C – 200°C	1L
915/09	VH Oil	150°C – 250°C	1L

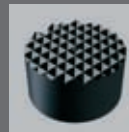

Infrared Calibration Mode with Blackbody Target **936-06-03**

Use optional Probe 936-14-61DB.



Surface Sensor Calibration with Surface Sensor Kit **936-06-04**

Includes an Insert and an angled platinum resistance thermometer.



ITS-90 Fixed Point Cells

B8 Water Triple Point Cell (Hyperion)
17401 Slim Gallium Slim Cell
936-06-09 Cell Holder Assembly



Calibration

Includes three point traceable calibration certificate for block temperature

UKAS Calibration

UKAS Calibration available to order, legally traceable in more than 70 countries.



Standard Probe **935-14-61/DB**

Platinum Resistance Thermometer. 4mm diameter.



Current Loop Interface **935-06-161**

24VDC Power Supply and Terminal Box. Powers 4-20mA Current Transmitters with 4mm terminal posts for easy connection.



Carrying Case **931-22-112**

Sturdy case with room for accessories. Features wheels and pull out handle.

Isocal-6 Performance and Use

Hyperion Performance - Dry Block

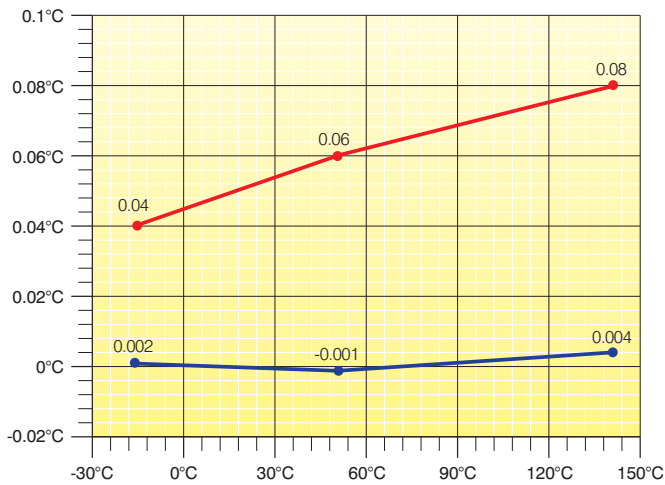

Drago Performance - Dry Block

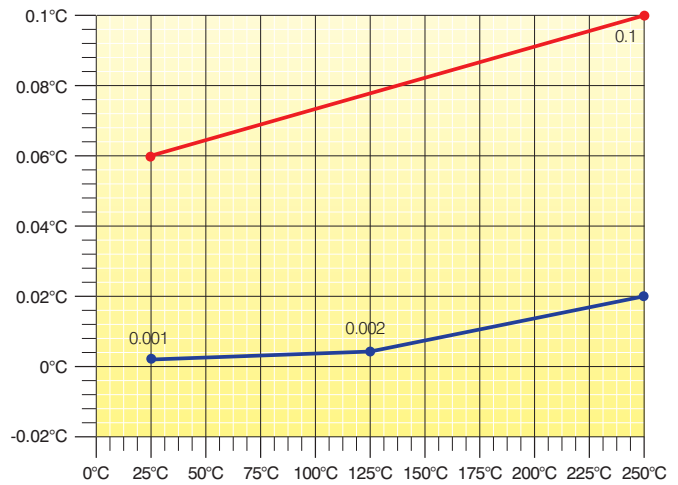

- Audit Calibration (Similar Sensors) S model with UKAS option
- Radial Homogeneity

See Evaluation Reports for full details
<http://www.isotech.co.uk>

Alternative Methods of Calibrating with an Isocal-6

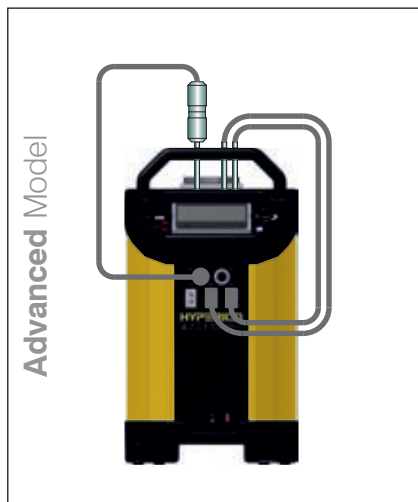

ADVANCED Model

- Digital Display of Set and Nominal Block Temperature
- Inbuilt three channel indicator for reference probe and units under test
- Advanced features including automatic Temperature Cycling and Logging
- Best Practice calibration with established traceability and uncertainty

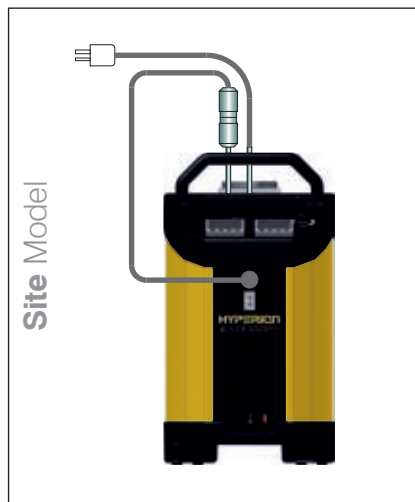

SITE Model

- Digital Display of Set and Nominal Block Temperature
- Inbuilt single channel indicator for reference probe
- Best Practice calibration with established traceability and uncertainty

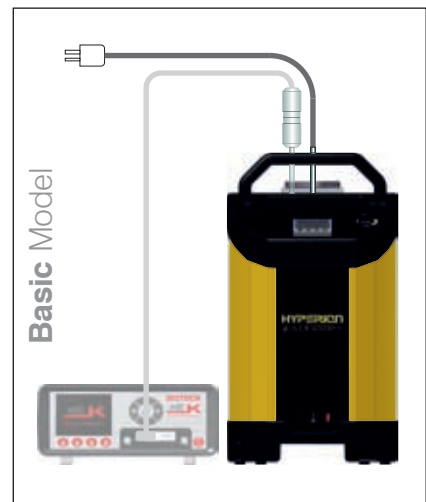

BASIC Model

- For Quick and Easy Testing
- Digital Display of Set and Nominal Block Temperature
- Use with a separate external indicator to compensate for gradients and loading



UKAS Calibration available for these systems - *International Traceability - Best Practice* See page 10

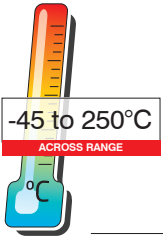

ISOCAL - 6 Range Europa Venus Calisto

- Multi Function: Six Modes including Dry Block and Liquid Bath
- Fast Response 35mm x 160mm Calibration Volume
- Calibrate Whole Measurement Loop

These models will calibrate temperature probes from -45°C to 250°C with unrivalled flexibility. As a traditional Dry Block, several thermometers can be quickly calibrated.

Accessories are available to convert to a stirred liquid bath, for surface sensor calibration, to calibrate infrared thermometers and even to use as an ITS-90 Fixed Point System with calibration uncertainties as small as 0.0005°C. With excellent stability and distributed heating cooling zones for good uniformity these calibrators offer proven thermal performance.

These award winning calibrators are easy to use and are available in three versions – the Basic, the Site and the ADVANCED. The Basic has a digital display of set and nominal temperature, the Site additionally includes an in-built independent temperature indicator for a reference probe. The ADVANCED controller has inputs for reference and test thermometers with a further range of sophisticated features including automatic temperature cycling, secure data logging and full colour high resolution display.

All models include I-Cal Easy LOG software and the ADVANCED models additionally include software to manage logged data and configure the unit, see page 10 for more details.

These models meet the calibration capacity requirements of EURAMET/cg-13/v.01, "EA Guidelines on the Calibration of Temperature Block Calibrators, formerly EA10/13. accuracy and best performance.



<http://www.isotech.co.uk/industrial/>



Parameter	Model		
	Europa 4520	Venus 4951	Calisto 4953
Temperature Range	-45°C to 140°C ⁽¹⁾	-35°C to 140°C ⁽²⁾	30°C to 250°C ⁽³⁾
ADVANCED Range			
Stability: Dry Block / Liquid Bath	±0.01°C	±0.01°C	±0.02°C
Display Resolution	0.001°C over whole range	0.001°C over whole range	0.01°C over whole range
Accuracy: RTD Input Channel	±0.05°C ±0.005% RDG		
Accuracy: Thermocouple Input Channel	E,J,K,N: ±0.2°C @ 660°C R: ±0.6°C S: ±0.7°C @ 660°C T ±0.2°C @ 150°C		
CJC Accuracy	±0.35°C		
BASIC/SITE Range			
Stability	±0.03°C	±0.03°C	±0.03°C
Display Resolution	0.01°C from -19.99 to 99.99C then 0.1C: 0.01C Over PC Interface		
COMMON Specification			
Stability	Blackbody ±0.3°C Surface Sensor ±0.5°C ITS-90 Cells ±0.0005°C		
Display Accuracy ⁴	0.15°C	0.15°C	0.25°C
Uniformity - Between Wells Dry Block Mode (Radial)	<0.008°C	<0.008°C	<0.02°C at 250°C
Uniformity - Lower 40mm (Axial) Dry Block Mode	<0.040°C	<0.040°C	<0.25°C
Uniformity - Radial Liquid Bath Mode	<0.02°C	<0.02°C	<0.011°C at 250°C
Uniformity - Lower 40mm (Axial) As Liquid Bath	<0.026°C	<0.026°C	<0.02°C at 250°C
Heating Time	-30°C to 140°C: 15 Mins	-30°C to 140°C: 15 Mins	25°C to 250°C: 15 Mins
Cooling Time	140°C to 0°C: 15 Mins	140°C to 0°C: 15 Mins	250°C to 30°C: 25 Mins
Calibration Volume	35 x 160mm		
Standard Insert	6 pockets, 2 x 4.5mm, 2 x 6.4mm, 1 x 8.0mm, 1 x 9.5mm diameter, all 157mm deep		
Insert Types	Choice of Three - See Accessories		
	Ethernet - supporting software and USB Host		
CJC Accuracy:	0.35°C		
Dimensions	384H (including handle) x 212W x 312D mm		
Power	300 Watts	150 Watts	300 Watts
Voltage	115Vac or 230 Vac 50/60Hz		
Weight	14kg	10.2kg	8kg

(1) In ambient of 20°C: Minimum Temperature is 65°C Below Ambient, Absolute Minimum -55°C
 (2) In ambient of 20°C: Minimum Temperature is 55°C Below Ambient, Absolute Minimum -45°C

(3) In ambient of 20°C
 (4) Dry Block Mode only: Comparing 4.5mm Well to Display Value.

	ADVANCED	SITE	BASIC
Digital Display of Set and Nominal Block Temperature	Yes	Yes	Yes
PC Interface	Ethernet + USB Host	Serial	Serial
Test Thermostats	Yes - Two Inputs	Yes - Single Input	No
Independent Temperature Indicator for Reference Probe	Yes	Yes	No
Additional Inputs for Units Under Test	Up to 3: Two universal inputs for PRT, Thermocouple or Process inputs and a further Thermocouple input	No	No
Automatic Temperature Cycling	Yes	No	No
Data Logging	Yes - Export to USB	No	No
Offset Elimination	Yes - block can follow reference input	No	No
Choose English, French, Italian or Spanish Language	Yes - on full colour display	No	No
In Built Web Server	Yes	No	No
Tamper Proof Data	Yes - Suitable for life science, automotive and aerospace applications	No	No

ISOCAL-6

LIQUID & DRY BLOCK



Metal Block Bath

Dry Block Calibrator provides fast and clean calibration of thermocouples, PRTs and other industrial sensors. Isotech blocks use a combination of multi zone and advanced materials technology to ensure constant temperature zones for high accuracy calibration.



Stirred Liquid Bath

Remove the metal block to convert to a stirred liquid bath. Liquid bath operation allows angled or awkward shaped probes to be calibrated. Accuracies are improved over Dry Blocks alone and with a suitable reference probe performance of 0.005°C is achievable.

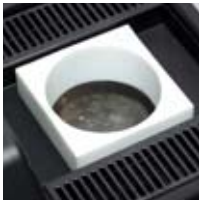

Stirred Ice / Water Bath

The ISOCAL-6 models that operate below 0°C can be used to provide a 0°C stirred ice / water bath. This provides a simple low cost way of checking that standards have not drifted in between calibrations.



Blackbody Source

Adding the blackbody target allows the testing of infrared thermometers. Low cost non-contact IR thermometers are increasingly being used in industry and the ISOCAL-6 is ideal to test and check these devices. The IR thermometer is focused on the target and compared to a reference probe in the block pocket.

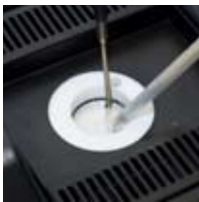

Surface Sensor Calibrator

With the Surface Sensor Kit the test sensor is compared to a platinum resistance thermometer located just below the surface of the block. Again save the cost of buying additional equipment by adding accessories as required to expand the ISOCAL-6 for new calibration applications.



ITS-90 Fixed Point Apparatus

For the best possible performance with uncertainties to 0.0005°C (0.5mK) add an ITS-90 Fixed Point Cell. The most popular is the B8 Water Triple Point Cell, it is surprisingly affordable and simple to use - the triple point can be both created and maintained in the apparatus without the need for any other equipment or supplies.



World's First
Multi-Functional
Baths
SIX FUNCTIONS

Europa Venus Calisto Accessories

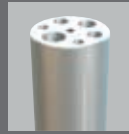

Dry Block Mode with Inserts

951-02-15 An Insert is included: (2 x 4.5mm, 2 x 6.4mm, 1 x 8mm & 1 x 9.5mm) x 157mm Deep. All Inserts have a 4mm tapped hole to suit supplied extractor tool.

Alternative Inserts

951-06-07 Alternative Insert type B 13mm, 10mm, 8mm, 5mm and 3.5mm dia. holes, all 157mm deep

951-06-08 Alternative Insert type C 8mm, 6 x 6.5mm dia. holes, all 157mm deep

951-02-15a Blank Insert without pockets for local machining. Includes M4 tapped hole for supplied extractor tool.

951-02-15c Custom insert. Isotech can provide custom drilled pockets, minimum of 3mm separation between holes.

Contact Isotech with your requirements

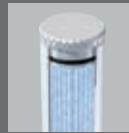
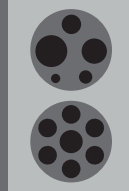

Stirred Liquid Mode with Liquid Container Kit 951-06-01

Allows liquid bath use, includes container, magnetic stirrer, probe guide and sealing cap.

Stirred Ice Bath Mode with Liquid Container Kit

Uses same liquid kit to provide 0°C reference as a stirred ice bath (Not Calisto)



Thermometer Support Kit 921-02-06

Allows three thermometers to be suspended in the bath, including liquid in glass types.

520-05-01	C10 Oil	-35°C – 140°C	0.1L
951-06-06	C20 Oil	20°C – 200°C	0.1L
953-04-01	VH Oil	150°C – 250°C	0.1L

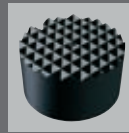

Infrared Calibration Mode with Blackbody Target 951-06-04

Use optional Probe **934-14-82/DB** placed in the auxiliary block pocket for use as a reference.



Surface Sensor Calibration with Surface Sensor Kit 951-06-02

Includes angled platinum resistance thermometer.

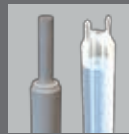

ITS-90 Fixed Point Cells 17724M

Slim Mercury Cell (Europa Only).

B8 Water Triple Point Cell (Venus and Europa)

17401M Slim Gallium Cell (Europa, Venus and Calisto)



Standard Probe 935-14-82/DB

Platinum Resistance Thermometer. Probe diameter 4mm, recommended pocket size 4.5mm. Angled head feature avoids sensors in block.



Current Loop Interface 935-06-161

24VDC Power Supply and Terminal Box. Powers 4-20mA Current Transmitters with 4mm terminal posts for easy connection.



Carrying Case 931-22-111

Sturdy case with room for accessories. Features wheels and pull out handle.

Isocal-6 Performance and Use

Venus and Europa

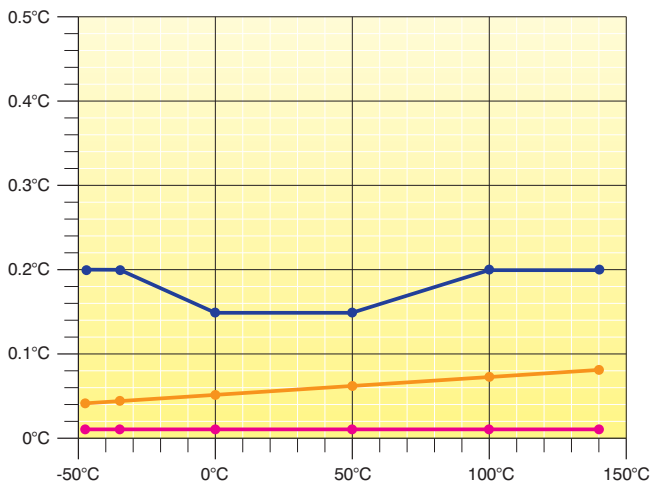

Calisto



- Uncertainty with Reference Probe with optional UKAS Calibration
- Audit Calibration: Method comparing a PRT to UKAS Calibrated model
- Radial Homogeneity. Use for similar probes and external indicator

See Evaluation Reports for full details
<http://www.isotech.co.uk>

Alternative Methods of Calibrating with an Isocal-6

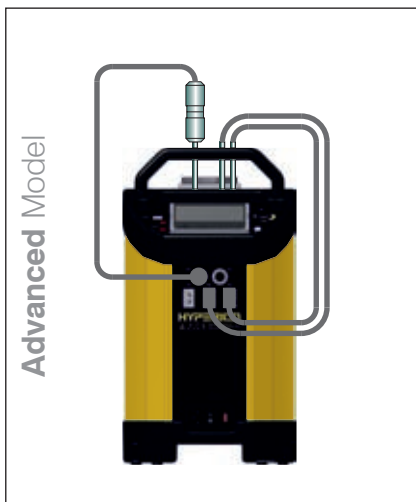

ADVANCED Model

- Digital Display of Set and Nominal Block Temperature
- Inbuilt three channel indicator for reference probe and units under test
- Advanced features including automatic Temperature Cycling and Logging
- Best Practice calibration with established traceability and uncertainty

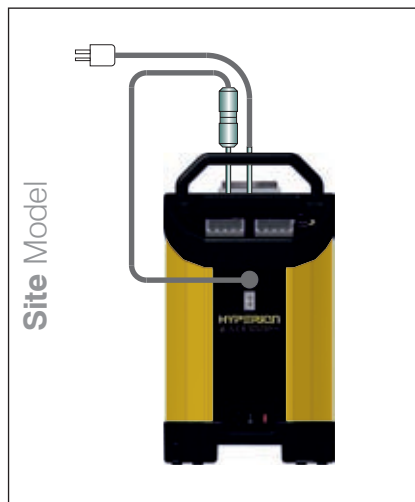

SITE Model

- Digital Display of Set and Nominal Block Temperature
- Inbuilt single channel indicator for reference probe
- Best Practice calibration with established traceability and uncertainty

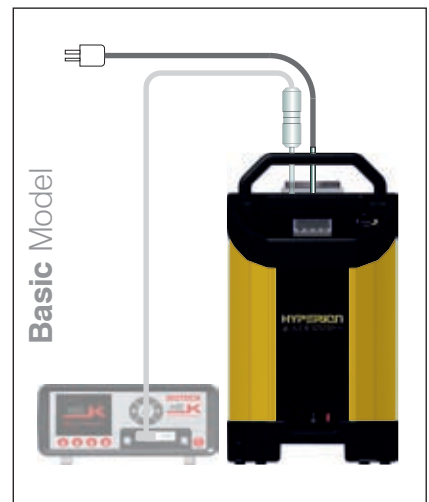

BASIC Model

- For Quick and Easy Testing
- Digital Display of Set and Nominal Block Temperature
- Use with a separate external indicator to compensate for gradients and loading



UKAS Calibration available for these systems - *International Traceability - Best Practice* See page 10



35 to 660°C

Dry Block Calibrator Jupiter

- Wide Operating Range to 660°C
- Fast Response
- Calibrate Whole Measurement Loop

The Jupiter Dry Block range offers industry-leading performance in an easy to use portable package - ideal for the calibration of thermocouples and platinum resistance thermometers. It has been designed for fast heating and cooling for convenient field use. For flexibility surface sensor and infrared thermometer accessories can be added.

The standard insert can hold up to six thermometers. For larger blocks see the Gemini range.

These award winning calibrators are easy to use and are available in three versions – the Basic, the Site and the ADVANCED. The Basic has a digital display of set and nominal temperature, the Site additionally includes an in-built independent temperature indicator for a reference probe. The ADVANCED controller has inputs for reference and test thermometers with a further range of sophisticated features including automatic temperature cycling, secure data logging and full colour high resolution display.

Isotech is a world leader in temperature calibration, providing many nations with their Primary Standards and operates a full scale UKAS accredited calibration laboratory. We can offer a range of calibration options to meet your requirements.

Benefit from our experience and understanding in calibration at all levels, our evaluation reports, our tutorials and uncertainty calculations.

These models meet the calibration capacity requirements of EURAMET/cg-13/v.01, "EA Guidelines on the Calibration of Temperature Block Calibrators, formerly EA10/13.

All models include I-Cal Easy LOG software and the



<http://www.isotech.co.uk/industrial/>

ADVANCED models additionally include software to manage logged data and configure the unit, see page 10 for more details.



Parameter	Model
	Jupiter 4852
Temperature Range	35°C to 660°C
ADVANCED Range	
Stability	±0.015°C @ 100°C ±0.025°C @ 650°C
Display Resolution	0.01°C over whole range
Accuracy: RTD Input Channel	±0.05°C ±0.005% RDG
Accuracy: Thermocouple Input Channel	E,J,K,N: ±0.2°C @ 660°C R: ±0.6°C S: ±0.7°C @ 660°C T ±0.2°C @ 150°C
CJC Accuracy	±0.35°C
BASIC/SITE Range	
Stability	±0.02°C @ 100°C ±0.03°C @ 650°C
Display Resolution	0.01°C from 30.00 to 99.99°C then 0.1°C: 0.01°C Over PC Interface
COMMON Specifications	
Display Accuracy ¹	0.5°C
Blackbody Source	±0.3°C
Surface Sensor Calibrator	±0.5°C
Cools from 650°C to 150°C	in 60 minutes
Heats from 30°C to 650°C	in 20 minutes
Best Performance	See Graph
Calibration volume	35mm diameter by 148mm deep
Standard Insert	6 pockets, 2 x 4.5mm, 2 x 6.4mm, 1 x 8.0mm, 1 x 9.5mm diameter, all 140mm deep
Indicator units	°C, °F, K
Power	115Vac or 230Vac 50/60Hz 1000 Watts
Dimensions	384H (including handle) x 212W x 312D mm
Weight	8.5kg

(1) Dry Block Mode only; Comparing 6.5mm Well to Display Value.

	ADVANCED	SITE	BASIC
Digital Display of Set and Nominal Block Temperature	Yes	Yes	Yes
PC Interface	Ethernet + USB Host	Serial	Serial
Test Thermostats	Yes - Two Inputs	Yes - Single Input	No
Independent Temperature Indicator for Reference Probe	Yes	Yes	No
Additional Inputs for Units Under Test	Up to 3: Two universal inputs for PRT, Thermocouple or Process inputs and a further Thermocouple input	No	No
Automatic Temperature Cycling	Yes	No	No
Data Logging	Yes - Export to USB	No	No
Offset Elimination	Yes - block can follow reference input	No	No
Choose English, French, Italian or Spanish Language	Yes - on full colour display	No	No
In Built Web Server	Yes	No	No
Tamper Proof Data	Yes - Suitable for life science, automotive and aerospace applications	No	No



UKAS Calibration available for these systems - *International Traceability - Best Practice* See page 10

Dry Blocks

FAST RESPONSE



Metal Block Bath

The Jupiter is supplied with an insert suitable for a wide range of sensors as standard.



Blackbody Source

Add the Blackbody accessory to allow calibration of infrared thermometers.

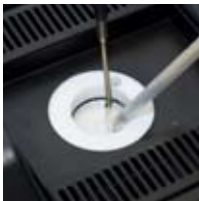

Surface Sensor Calibrator

The Jupiter can calibrate surface sensors by adding the surface sensor kit.

Jupiter Accessories

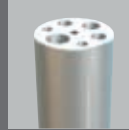

Metal Block Insert 852-07-11

Standard Insert included.
Size: 2 x 4.5mm, 2 x 6.4mm, 1 x 8mm and 1 x 9.5mm all 140mm deep

Alternative Inserts

852-09-03 Alternative Insert type B 13mm, 10mm, 8mm, 5mm and 3.5mm diameter holes, all 140mm deep

852-09-04 Alternative Insert type C 8mm, 6 x 6.5mm diameter holes, all 140mm deep

852-07-07 Blank Insert without pockets for local machining. Includes M4 tapped hole for supplied extractor tool.

852-07-07C Custom Insert. Isotech can provide custom drilled pockets, minimum of 3mm separation between holes. Contact Isotech with your requirements.

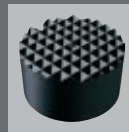
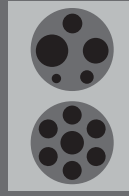

Blackbody Kit 852-09-05

Includes a Blackbody target and Sensor.



Surface Sensor Kit 852-07-15

Includes angled thermocouple.



Calibration

Includes three point traceable calibration certificate for block temperature

UKAS Calibration

Recommended: Options for block temperature and reference thermometer inputs (simulation). Legally traceable in more than 70 countries.

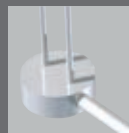

Air Cooling 853-04-02

For use with an air supply this accessory allows air to be blown into the block for rapid cooling.



Standard Probe 935-14-72/DB

Platinum Resistance Thermometer for use up to 660°C. Probe diameter 6mm, recommended pocket size 6.5mm.



Current Loop Interface 935-06-161

24VDC Power Supply and Terminal Box. Powers 4-20mA Current Transmitters with 4mm terminal posts for easy connection.



Carrying Case 931-22-111

Sturdy case with room for accessories. Features wheels and pull out handle.



The world's leading National Metrology Institutes choose Isotech - shouldn't you?

Isotech manufacture the widest range of temperature calibration equipment from hand held thermometers to Primary Standards. With Isotech solutions you can expand your equipment no matter what the requirement.

Isotech have been pioneering the latest developments in Temperature Metrology for more than 30 years, benefit from our know how, experience and global network.

Jupiter Benefits

- The Jupiter calibration block features uniform heating with a custom wound heater over an extended length of the block. The block itself is made from copper which has a very high thermal conductivity; much

superior to the aluminium bronze alloys used elsewhere. A propriety process is used to protect the copper from oxidising. This combination of materials and expert knowledge delivers superior performance.

660°C Operation

- The Jupiter ADVANCED operates to a maximum of 660°C; matched to the upper limit of the high temperature Isotech Semi Standard Platinum Resistance Thermometers. This allows maximum accuracy with no risk to exceeding the temperature limit of the PRT. This gives greater accuracy than extending the range beyond 660°C and having to use an inferior thermometer or thermocouple.

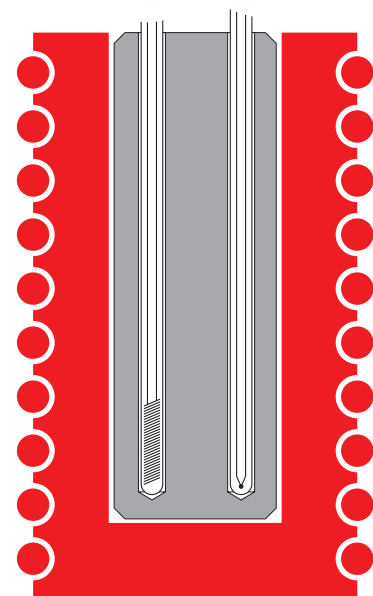

Superior uniformity by using copper block with extended length heating

Jupiter

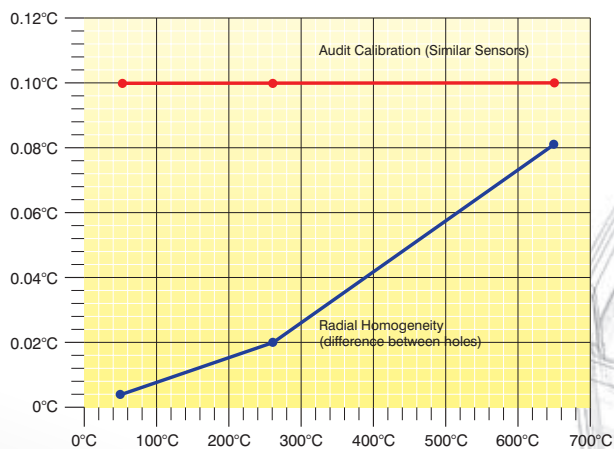

- Audit Calibration (Similar Sensors)
- Radial Homogeneity

See Evaluation Reports for full details
<http://www.isotech.co.uk>

How To Order

- 1 - Select Desired Options and Accessories
- 2 - Supply Voltage:
Specify either 115Vac 50/60Hz or 230Vac 50/60Hz

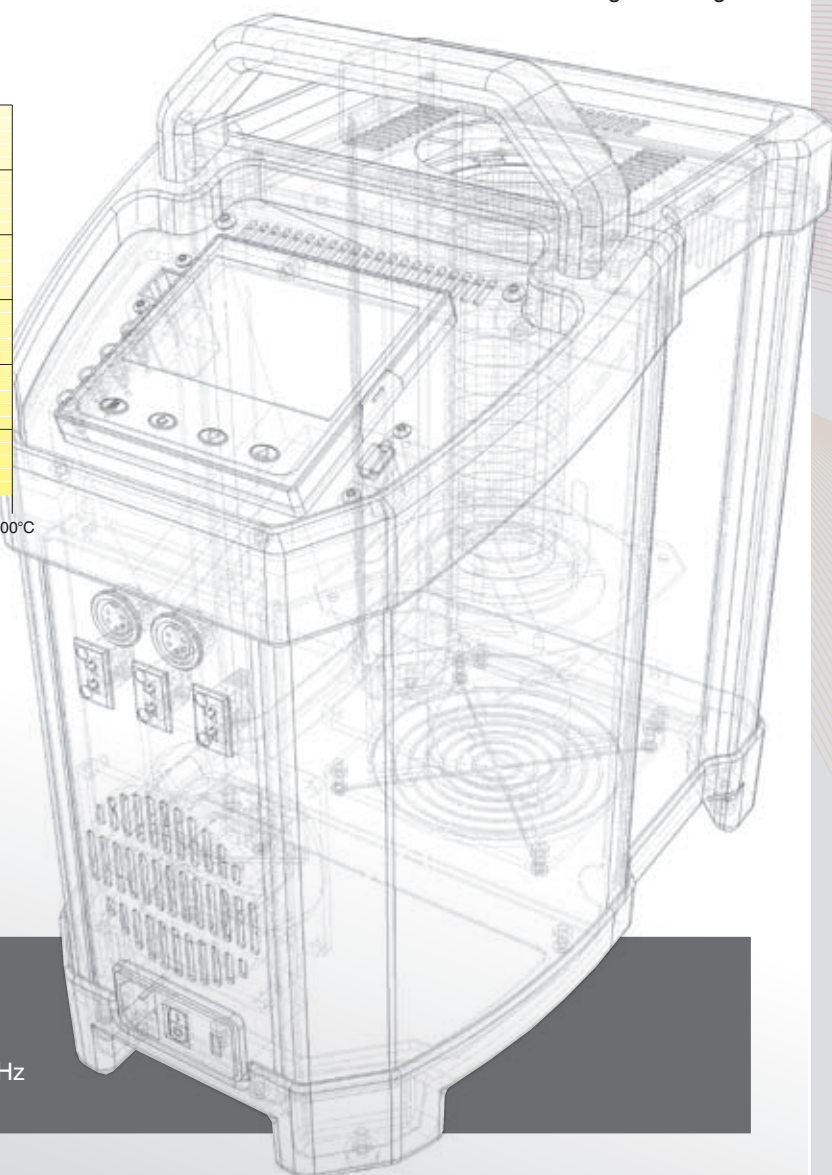



35 to 700°C

Dry Block Calibrator Gemini

- Calibrate Large Diameter Probes
- High Capacity Blocks 64 x 160mm
- Calibrate Whole Measurement Loop

The Gemini range of Dry Blocks have high capacity allowing a large number of probes to be calibrated together. They are also suitable to accept large diameter probes with the block volume of a nominal 64 x 160mm.

Whilst the large block takes longer to heat and cool than the Jupiter it can calibrate thermocouples, resistance thermometers, thermostats and sensors that are too large for the smaller blocks.

These award winning calibrators are easy to use and are available in three versions – the Basic, the Site and the ADVANCED. The Basic has a digital display of set and nominal temperature, the Site additionally includes an in-built independent temperature indicator for a reference probe. The ADVANCED controller has inputs for reference and test thermometers with a further range of sophisticated features including automatic temperature cycling, secure data logging and full colour high resolution display.

All models include I-Cal Easy LOG software and the ADVANCED models additionally include software to manage logged data and configure the unit, see page 10 for more details.

Available with a fixed block with four 8mm and four 19.5mm pockets or the LRI version which has a removable block. With the LRI model, blocks can be drilled to custom configurations.

Isotech is a world leader in temperature calibration, providing many nations with their Primary Standards and operates a full scale UKAS accredited calibration laboratory. We can offer a range of calibration options to meet your requirements.



<http://www.isotech.co.uk/industrial/>

These models meet the calibration capacity requirements of EURAMET/cg-13/v.01, "EA Guidelines on the Calibration of Temperature Block Calibrators, formerly EA10/13.



Parameter	Model: Gemini 4857	
	550	700
Temperature Range	35°C to 550°C	50°C to 700°C
ADVANCED Range		
Absolute Stability over 30 mins	±0.01°C @ 100°C ±0.015°C @ 300°C ±0.03°C @ 550°C	
Display Resolution	0.01°C over whole range	
Accuracy: RTD Input Channel	±0.05°C ±0.005% RDG	
Accuracy: Thermocouple Input Channel	E,J,K,N: ±0.2°C @ 660°C R: ±0.6°C S: ±0.7°C @ 660°C T ±0.2°C @ 150°C	
CJC Accuracy	±0.35°C	
BASIC/SITE Range		
Absolute Stability over 30 mins	±0.02°C @ 50°C ±0.03°C @ 250°C ±0.04°C @ 550°C	
Display Resolution	0.01°C from 30.00 to 99.99°C then 0.1°C: 0.01°C Over PC Interface	
COMMON Specifications		
Display Accuracy ¹	0.5°C	
Cools from 550°C to 275°C from 550°C to 60°C	35 mins (LRI: 132 mins) 345 mins (LRI: 420 mins)	- -
Heats from 30°C to 550°C from 50°C to 700°C	35 mins (LRI: 60 mins) -	- 110 mins (LRI: 120 mins)
Best Performance	See Graph	
Calibration volume	65mm diameter x 160mm deep	
Indicator units	°C, °F, K	
Voltage	115Vac or 230Vac 50/60Hz	
Power	600 Watts (LRI: 1000 Watts)	
Dimensions	384H (including handle) x 212W x 312D mm	
Weight	8.5kg	14kg

(1) Dry Block Mode only: Comparing 6.5mm Well to Display Value.

	ADVANCED	SITE	BASIC
Digital Display of Set and Nominal Block Temperature	Yes	Yes	Yes
PC Interface	Ethernet + USB Host	Serial	Serial
Test Thermostats	Yes - Two Inputs	Yes - Single Input	No
Independent Temperature Indicator for Reference Probe	Yes	Yes	No
Additional Inputs for Units Under Test	Up to 3: Two universal inputs for PRT, Thermocouple or Process inputs and a further Thermocouple input	No	No
Automatic Temperature Cycling	Yes	No	No
Data Logging	Yes - Export to USB	No	No
Offset Elimination	Yes - block can follow reference input	No	No
Choose English, French, Italian or Spanish Language	Yes - on full colour display	No	No
In Built Web Server	Yes	No	No
Tamper Proof Data	Yes - Suitable for life science, automotive and aerospace applications	No	No



UKAS Calibration available for these systems - *International Traceability - Best Practice* See page 10

Dry Blocks

LARGE VOLUME

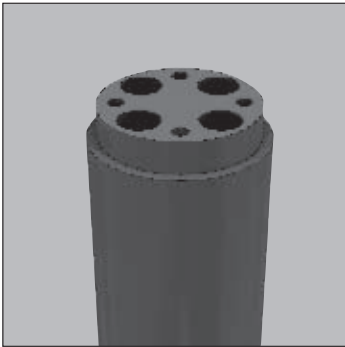

Gemini Fixed Block

Four 8mm Pockets
Four 19.5mm Pockets

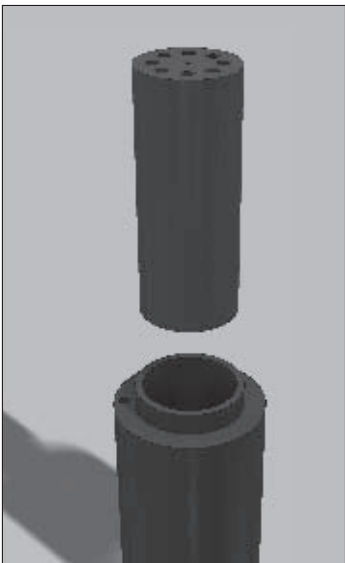

Gemini LRI Removable Block

Eight 8mm Pockets
Can be custom drilled



Gemini Accessories

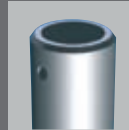

Metal Block Sleeves

Gemini 550

Set of four Sleeves to suit the block. Optional single hole sizes 4, 6, 8, 10, 12, 14mm diameter all 150mm deep.

857-07-01 Undrilled sleeves for local machining.

857-07-03 1 sleeve with 2 holes 4.5mm x 150mm deep.

Gemini 700

Set of four Sleeves to suit the block. Optional single hole sizes 4, 6, 8, 10, 12, 14mm diameter all 150mm deep.

857-07-02 Blank sleeves for local machining.

857-07-04 1 sleeve with 2 holes 4.5mm x 150mm deep.

Note: The use of sleeves will introduce an additional thermal gradient into the block. This can be avoided by using the LRI model with a block drilled for specific probes.

Removable Inserts

Gemini 550 LRI

976-07-01a Included as Standard Removable insert with eight 8mm pockets

976-07-01b Blank Insert

Insert without pockets for local machining

976-07-01c Custom Insert

Contact Isotech with your requirements

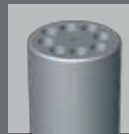

Gemini 700 LRI

976-07-02a Included as Standard Removable block with eight 8mm pockets

976-07-02b Blank Insert

Insert without pockets for local machining

976-07-02c Custom Insert

Contact Isotech with your requirements



Calibration

Includes three point traceable calibration certificate for block temperature

UKAS Calibration

Recommended: Options for block temperature and reference thermometer inputs (simulation). Legally traceable in more than 70 countries.



Current Loop Interface

935-06-161 24VDC Power Supply and Terminal Box. Powers 4-20mA Current Transmitters with 4mm terminal posts for easy connection.



Standard Probe

935-14-72/DB Platinum Resistance Thermometer for use up to 650°C.

935-14-63 Type N Thermocouple for use up to 700°C.



Carrying Case

931-22-111 - Gemini 550 / 700

931-22-112 - Gemini 550 LRI / 700 LRI

Sturdy case with room for accessories. Features wheels and pull out handle.



The world's leading National Metrology Institutes choose Isotech - shouldn't you?

Isotech manufacture the widest range of temperature calibration equipment from hand held thermometers to Primary Standards. With Isotech solutions you can expand your equipment no matter what the requirement.

Isotech have been pioneering the latest developments in Temperature Metrology for more than 30 years, benefit from our know how, experience and global network.

Gemini Benefits

- The Gemini has a large block with sufficient mass to accommodate larger sensors or a larger number of sensors. The fixed block has four 19.5mm pockets and four 8mm pockets.
- The LRI model with its removable block can be custom drilled. Whilst the larger block takes longer to heat than the fast response models they do allow larger probes to be accommodated and can be used with custom blocks to simulate applications, allowing probes that would otherwise be unsuitable for Dry Block calibration to be evaluated.



Gemini

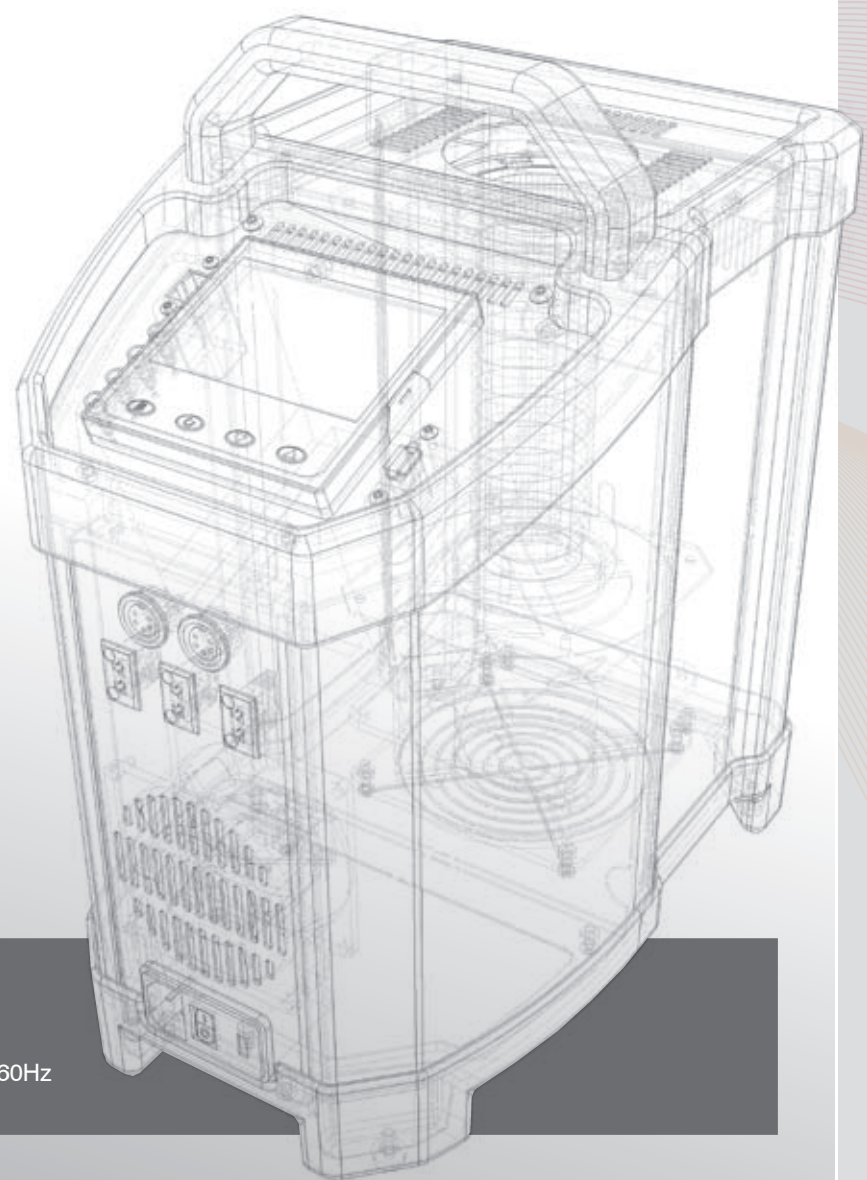
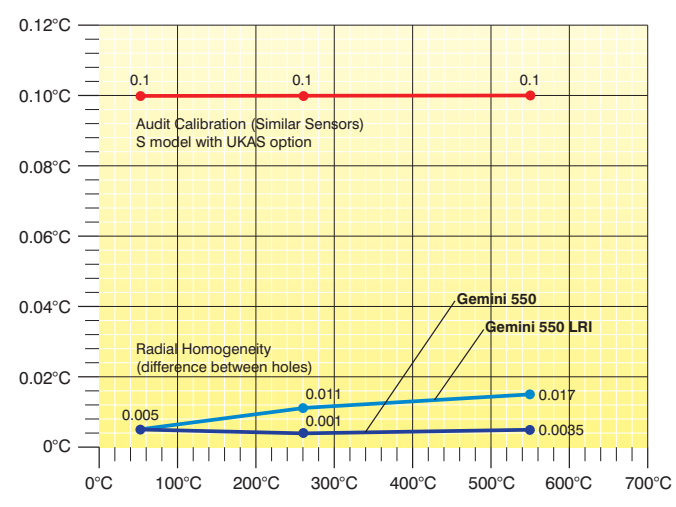

How To Order

- 1 - Select Desired Options and Accessories
- 2 - Supply Voltage:
Specify either 115Vac 50/60hz or 230Vac 50/60Hz



150 to 1200°C

Dry Block Calibrator Pegasus

- High Temperature Thermocouple Calibration Furnace
- Custom Furnace Design with Optimised Profile
- Calibrate Whole Measurement Loop

The Pegasus range offers extreme high temperature calibration in an easy to use portable package - ideal for the calibration of high temperature thermocouples. It has been designed for fast heating and finds applications in the glass, electrical power, automotive and material processing industries.

A Blackbody target can be added for the calibration of infrared thermometers.

The standard insert has four 8mm pockets 80mm deep. The metal insert is strategically placed beneath 50mm of insulation to provide optimal performance over the radiant temperature range.

The optional Blackbody target is used with a specially angled Type R thermocouple that sits immediately behind the target area.

These award winning calibrators are easy to use and are available in three versions – the Basic, the Site and the ADVANCED. The Basic has a digital display of set and nominal temperature, the Site additionally includes an in-built independent temperature indicator for a reference probe. The ADVANCED controller has inputs for reference and test thermometers with a further range of sophisticated features including automatic temperature cycling, secure data logging and full colour high resolution display.

The B model should be used with an external reference probe and indicator, such as the millIK. The thermocouples



under test should be calibrated by comparison to the external probe.

All models include I-Cal Easy LOG software and the ADVANCED models additionally include software to manage logged data and configure the unit, see page 10 for more details.



UKAS Calibration available for these systems - *International Traceability - Best Practice* See page 10



Parameter	Model
	Pegasus 4853
Temperature Range	150°C to 1200°C
ADVANCED Range	
Stability	±0.05°C @ 150°C ±0.08°C @ 1200°C
Display Resolution	0.01°C over whole range
Input Channel Accuracy: Thermocouple	E,J,K,N: ±0.2°C @ 660°C R: ±0.6°C S: ±0.7°C @ 660°C T ±0.2°C @ 150°C
CJC Accuracy	±0.35°C
Input Channel Accuracy: RTD	±0.05°C ±0.005% RDG
BASIC / SITE Range	
Stability	±0.1°C @ 150°C ±0.2°C @ 1200°C
Display Resolution	0.1°C from 150°C to 999.9°C then 1°C: 0.01°C Over PC Interface
COMMON Specifications	
Blackbody Source	±0.3°C
Cools from 1200°C to 800°C 1200°C to 200°C	in 50 minutes* in 180 minutes* *substantially reduced by the cooling adaptor
Heating Rate	25°C / minute
Best Performance	See Graph
Calibration volume	33.5mm diameter by 130mm deep
Standard Insert	4 x 8mm Pockets all 80mm deep + 50mm top insulator
Indicator units	°C, °F, K
Power	115Vac or 230Vac (50 / 60 Hz) 800 Watts
Dimensions	384H (including handle) x 212W x 312D mm
Weight	13kg

	ADVANCED	SITE	BASIC
Digital Display of Set and Nominal Block Temperature	Yes	Yes	Yes
PC Interface	Ethernet + USB Host	Serial	Serial
Test Thermostats	Yes - Two Inputs	Yes - Single Input	No
Independent Temperature Indicator for Reference Probe	Yes	Yes	No
Additional Inputs for Units Under Test	Up to 3: Two universal inputs for PRT, Thermocouple or Process inputs and a further Thermocouple input	No	No
Automatic Temperature Cycling	Yes	No	No
Data Logging	Yes - Export to USB	No	No
Offset Elimination	Yes - block can follow reference input	No	No
Choose English, French, Italian or Spanish Language	Yes - on full colour display	No	No
In Built Web Server	Yes	No	No
Tamper Proof Data	Yes - Suitable for life science, automotive and aerospace applications	No	No

Dry Blocks

HIGH TEMPERATURE



Metal Block Bath

The Pegasus includes an insert suitable for high temperature calibration of thermocouples.

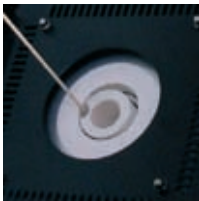

Blackbody Source

Add the Blackbody accessory to allow calibration of infrared thermometers.

Pegasus Accessories

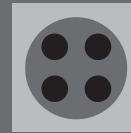

Metal Block Insert

Standard Insert Included
Four 8mm pockets. Pocket depth 80mm + 50mm insulator. Effective depth 130mm.
853-06-02 Blank Insert
Insert without pockets for local machining
853-06-02b Custom Insert
Contact Isotech with your requirements

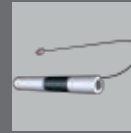

Blackbody Kit 853-06-03

Includes a Blackbody target and Sensor



Calibration

Includes three point traceable calibration certificate for block temperature

UKAS Calibration

Recommended: Options for block temperature and reference thermometer inputs (simulation). Legally traceable in more than 70 countries.



Standard Probe 935-14-91

Type R Platinum Thermocouple for use up to 1200°C.

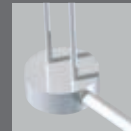

Air Cooling 853-04-02

For use with a compressor this accessory allows air to be blown into the block for rapid cooling.

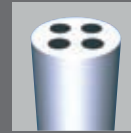

Ceramic Insulators 853-06-04

Spare insulation pack Includes 2 x standard tops and 2 x standard bottoms.



Current Loop Interface 935-06-161

24VDC Power Supply and Terminal Box. Powers 4-20mA Current Transmitters with 4mm terminal posts for easy connection.



Carrying Case 931-22-111

Sturdy case with room for accessories. Features wheels and pull out handle.



The world's leading National Metrology Institutes choose Isotech - shouldn't you?

Pegasus Benefits

The Pegasus features a small tube furnace to allow operation to 1200°C in a portable case. With a ceramic furnace construction temperature gradients are larger than with lower temperature metal blocks.

The Isotech furnace benefits by using a specially wound furnace tube assembly. They are manufactured in our factory with the turns concentrated at the ends of the furnace, where the heat losses are greatest. This gives an

improved temperature profile and lower uncertainty.

Insulators are provided for the top and bottom of the furnace which further improve temperature uniformity.

The effective immersion depth is 130mm, 80mm in the metal insert and then a further 50mm in the furnace tube.

Benefit from Isotech's design and experience

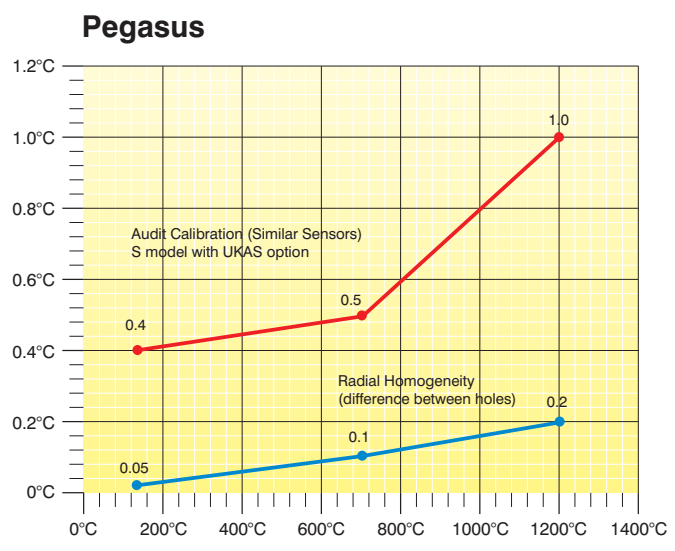
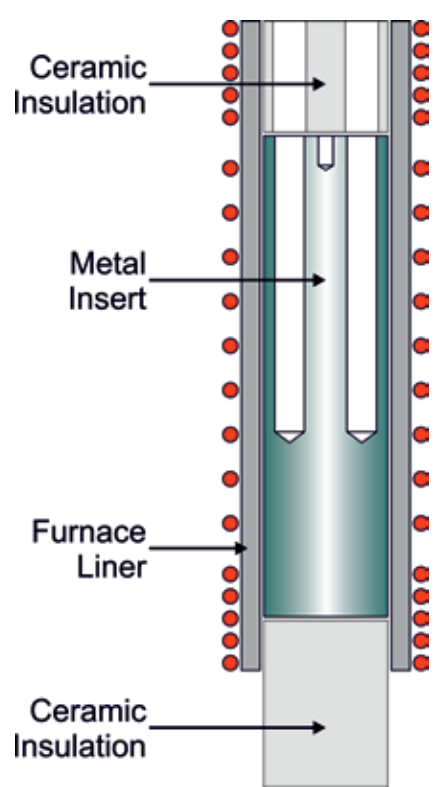

- Audit Calibration (Similar Sensors)
- Radial Homogeneity

See Evaluation Reports for full details
<http://www.isotech.co.uk>

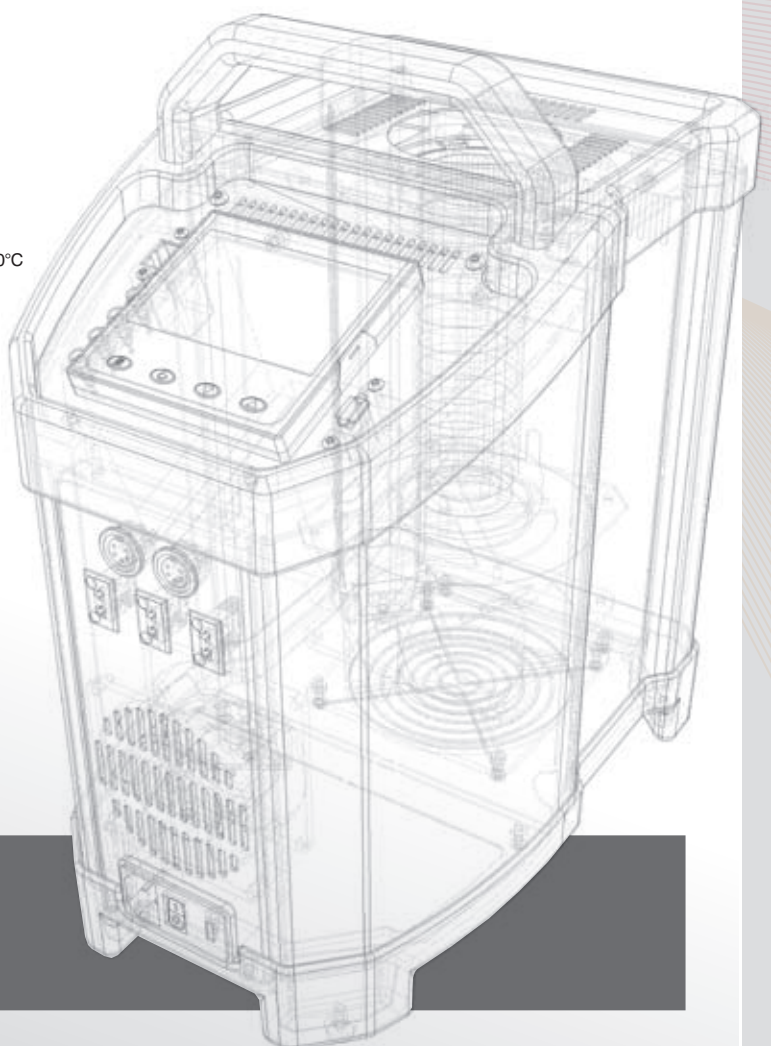

How To Order

- 1 - Select Desired Options and Accessories
- 2 - Supply Voltage:
Specify either 115Vac 50/60hz or 230Vac 50/60Hz



ISOTECH

The Source for Calibration Professionals

Telephone: +44 (0)1704 543830

Fax: +44 (0)1704 544799 Email: info@isotech.co.uk

Isothermal Technology Limited

Pine Grove, Southport, Merseyside PR9 9AG England

www.isotech.co.uk

