

ISOLATED
SIGNAL
CONVERTER

Serie ISC

SIGNAL CONVERTERS
WITH GALVANIC ISOLATION

FEMA ELECTRÓNICA

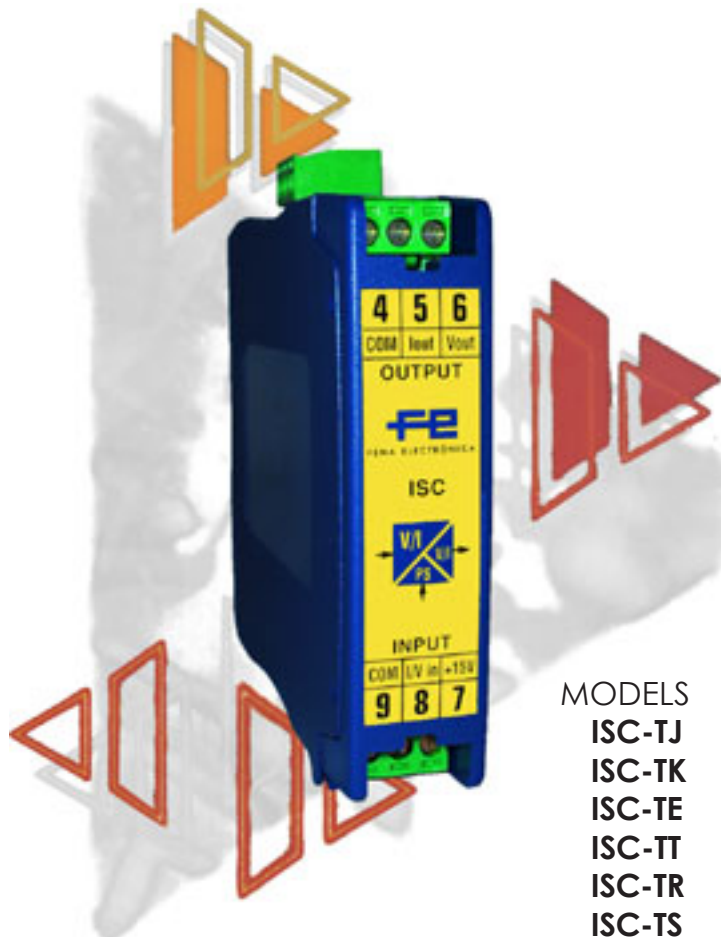

MODELS
ISC-TJ
ISC-TK
ISC-TE
ISC-TT
ISC-TR
ISC-TS

FEMA
ELECTRÓNICA®

USER'S MANUAL

HT0603r150908

info@fema.es
www.fema.es

0-INDEX

1-GENERAL INFORMATION	3
2-INSTALLATION	4
3-DIMENSIONS AND CONNECTIONS	5
4-SIGNAL INPUT JUMPERS	6
5-SIGNAL OUTPUT JUMPERS	7
6-READJUSTING INPUT/OUTPUT	7
7-TECHNICAL DATA-I	8
INPUT SIGNAL for THERMOCOUPLES	8
(THERMOCOUPLES «J» «K» «T» «E» «R» «S»)	
DETECTION OF BROKEN PROBE	8
IMPEDANCES and OVERVOLTAGES	8
ERROR DUE TO COLD JUNCTION	8
OUTPUT SIGNAL in Vdc	8
OUTPUT SIGNAL in mA	8
POWER SUPPLY	8
MECHANICAL DIMENSIONS	8
GALVANIC ISOLATION	8
MATERIALS	8
8-TECHNICAL DATA-II	9
9-CE DECLARATION OF CONFORMITY	9
10-CAUTIONS, WARNINGS AND NOTES	10
11-WARRANTY	11
OTHER PRODUCTS	12

1-GENERAL INFORMATION

The ISC series of Isolated Signal Converters, allow to convert process signals, temperatures, electrical signals, etc, to current loops or voltage signals for further retransmission, while introducing into the system galvanic isolation barriers between the input, the output and the power supply circuits.

The ISC series of Isolated Signal Converters, offer an excellent relation between signal conversion speed and measurement accuracy. Offering a 0.2% accuracy and up to a 70ms response time depending on the model, these units can process information coming from probes or transducers, in such a way that can be quickly retransmitted in a fast and accurate form to remote data acquisition systems or PLC's. The isolated signal converters of the ISC series are ideal to integrate into 12 bit data acquisition systems.

Its powerful galvanic isolation of 3.500 V introduces high security to the measuring systems, preventing the propagation of those phenomenon which usually cause damage to the remote system, such as transient peaks or energy shocks in any of the circuits of the system. The galvanic isolation also acts as a strong CE barrier. The decoupling created between the input, output and power circuits avoids pernicious effects on the output, such as ground loops or signal leaks, which distort the acquired data and are extremely difficult to isolate once introduced into the signal.

The isolation offered by the ISC series of Isolated Signal Converters is a 3 way isolation. Thus, all the benefits exposed above are applicable to any of the three circuits composing the instrument : input, output and power.

Recalibration of the instruments is realized in a fast and easy way. Opening the front cover grants access to the configuration jumpers. Additional Span and Offset potentiometers are directly accessible from the frontal part. These potentiometers are highly decoupled, minimizing the iterations needed to obtain a correct adjustment.

In order to obtain a higher and quickest benefit of the ISC units, we recommend you to read carefully the information provided in this manual before proceeding to the installation of the instrument. In this manual you will find all technical data, both electrical and mechanical, needed for a correct instalation and utilization.

Note : The ISC Isolated Signal Converter instruments have a characteristics label attached on the side of the instrument. Check that the information indicated on the label matches with your application requirements, and specially check that the value and type of the power supply needed matches the value and type of the power supply available on your installation.

2-INSTALLATION

Before installing the instrument check the characteristics label attached to the side of the unit. Specially check that the value of the power supply needed, matches the power supply available on your installation.

The characteristics label also indicates the input/output signal relation for the instrument. Remember to take note of the new input/output relation if you proceed to readjust the instrument.

To access the selection jumpers for input and output ranges, and the Span and Offset potentiometers, slightly press the A-A points of the front cover as indicated on Figure 1.

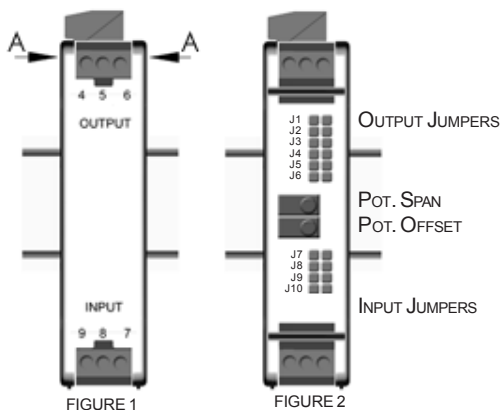

FIGURE 1

FIGURE 2

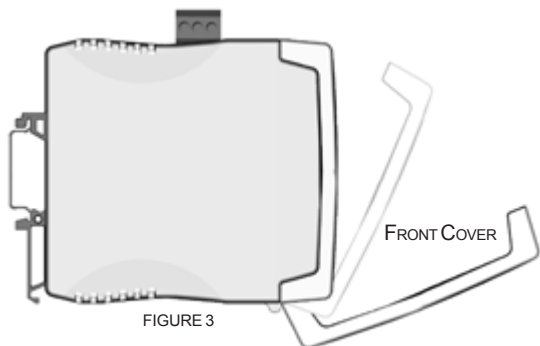

FIGURE 3

The instrument must be installed in such a way that it remains in vertical position as indicated on Figure 4.

To help dissipate the heat, a free space of 2mm must be left available on both sides of the instrument.

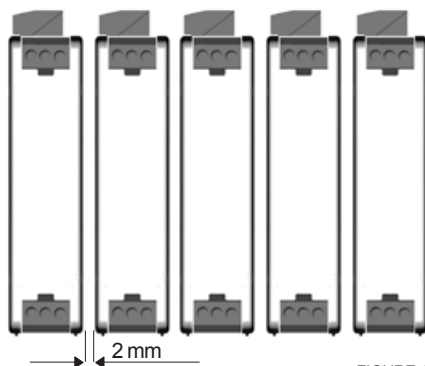

FIGURE 4



IMPORTANT - Opening the front cover may grant access to areas with dangerous voltages. Operations must be performed by qualified technical staff.

3-DIMENSIONS AND CONNECTIONS

Output Connections

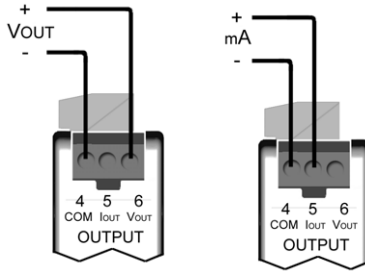

Input Connections

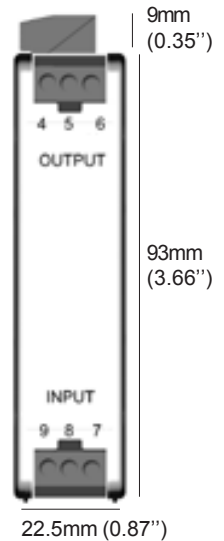
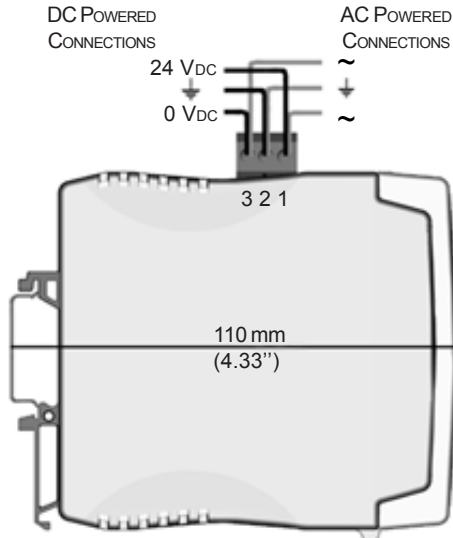
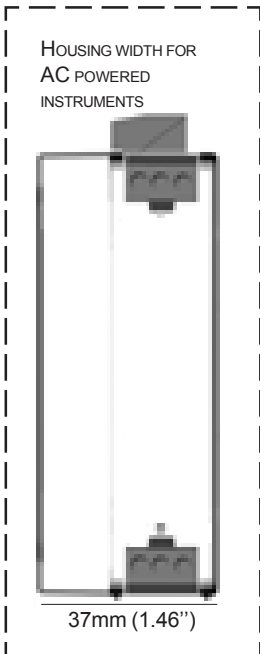
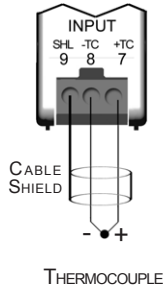

4-SIGNAL INPUT JUMPERS _____

The position of the input jumpers selects the range for the input signal as indicated below.

THERMOCOUPLE «J»

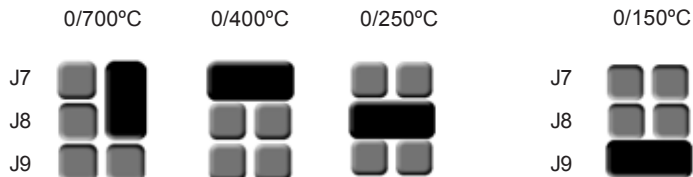

THERMOCOUPLE «K»

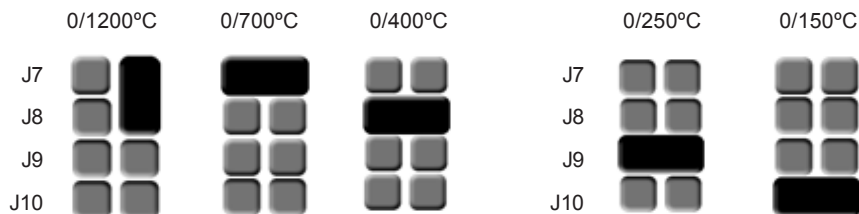

THERMOCOUPLE «E»

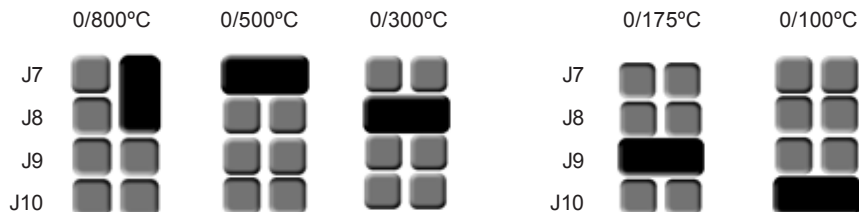

THERMOCOUPLE «T»

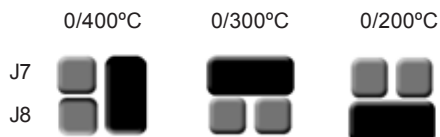

THERMOCOUPLE «S» and «R»

Thermocouple «S» - 0/1600°C

Thermocouple «R» - 850/1700°C

5-SIGNAL OUTPUT JUMPERS

The position of the output jumpers selects the range for the output signal as indicated below.

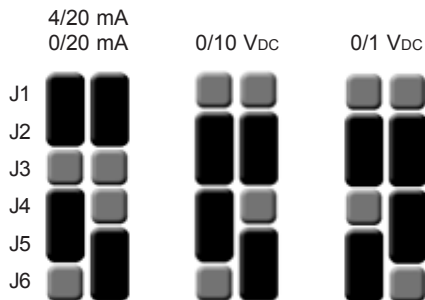

6-READJUSTING INPUT / OUTPUT

To change the input/output relation of the instrument, proceed as indicated below :

- 1.- Open the front cover
 - 2.- Select the required input jumpers (*Section 4, page 6*)
 - 3.- Select the required output jumpers (*Section 5, page 7*)
 - 4.- Connect a thermocouple simulator to the input terminals using compensated cable of the appropriate thermocouple type (*Section 3, page 5*)
 - 5.- Connect a multimeter to the output terminals (*4 and 5 for mA or 4 and 6 for Vdc*)
- (Following values in brackets are examples for readjusting the input/output relation of the instrument to 0/800°C = 0/10 Vdc)*
- 6.- Generate the low input signal (*0°C*)
Operate the OFFSET potentiometer, until the low output value is reached (*0Vdc*)
 - 7.- Generate the high input signal (*800°C*)
Operate the SPAN potentiometer, until the high output value is reached (*10Vdc*)
 - 8.- Repeat 6 and 7 to improve the accuracy until it reaches its specified value
 - 9.- Close the front cover



IMPORTANT - Opening the front cover may grant access to areas with dangerous voltages. Operations must be performed by qualified technical staff.

7-TECHNICAL DATA - I

INPUT SIGNAL for THERMOCOUPLES

THERMOC.«J»	THERMOC.«T»
0/700°C	0/400°C
0/400°C	0/300°C
0/250°C	0/200°C
0/150°C	

THERMOC.«K»	THERMOC.«E»
0/1200°C	0/800°C
0/700°C	0/500°C
0/400°C	0/350°C
0/250°C	0/175°C
0/150°C	0/100°C

THERMOC.«S»	THERMOC.«R»
0/1600°C	850/1700°C

DETECTION OF BROKEN PROBE

Output to high level

IMPEDANCES and OVERVOLTAGES

Zin	1 Mohm
Overvoltage	10 Vdc Max.

ERROR DUE TO COLD JUNCTION

J,K,T,E	0,05 °C/°C
R,S	0,1 °C/°C

Cold Junction Compensation - Automatic

OUTPUT SIGNAL in Vdc

RANGES	0/10Vdc
	0/1Vdc

Maximum Output	11Vdc aprox.
Minimum Output	-1Vdc aprox.
Minimum Load	≥1KOhm

OUTPUT SIGNAL in mA

RANGES	0/20mA (4/20mA)
---------------	-----------------

Maximum Output	22mA aprox.
Minimum Output	-1.5mA aprox.
Maximum Load	≤400 Ohms

POWER SUPPLY

DC Power	24Vdc±10%
AC Power	230Vac±10% 50/60 Hz
	115Vac±10% 50/60 Hz
Consumption	<3.8VA

MECHANICAL DIMENSIONS

DC Powered	22.5 x 93 x 110 mm
AC Powered	37.0 x 93 x 110 mm
Weight DC	120 gr.
Weight AC	200 gr.

Standard DIN rail mounting (DIN46277, DIN EN 50022)

37,5 x 7,5 mm (1,38 x 0,3 ")

GALVANIC ISOLATION

DC Powered Units	
Input - Output	3K5 (60 seconds)
Power - Input	3K5 (60 seconds)
Power - Output	1KV (60 seconds)

AC Powered Units	
Input - Output	3K5 (60 seconds)
Power - Input	3K5 (60 seconds)
Power - Output	3K5 (60 seconds)

All isolation levels are tested during a time of 60 seconds, with Vac TrueRMS signal, and current leaks <1mA

Note : Indicated isolation levels are also sometimes named as STRENGTHENED ISOLATION levels, for systems with Pollution Level 2

MATERIALS

Box and Cover in Poliamide PA6 UL94 V-2 blue color

Terminals in Poliamide UL94 V-0

8-TECHNICAL DATA - II

Accuracy	<0.3% F.S. Optimized for 12 bit systems
Linearity	<0.2% F.S.
Thermal Drift	250 ppm/°C Typical
Compensation Thermal Drift	0.1°C/°C
Response Time	<250mS (90% of signal)
Warm-Up Time	15 minutes
Electrical Connections	Plug-in Screw Terminals
Maximum Wire Section	2.5 mm ²
Protection	IP-30
Operating Temperature	0 to 60°C
Storage Temperature	-20 to +70°C

9-CE DECLARATION OF CONFORMITY

Manufactured by : FEMA ELECTRÓNICA, S.A.
Address: Pol. Ind. Santiga - Altimira 14 (T14 - N2)
 E 08210-Barberà del Vallès - BARCELONA
 ESPAÑA- SPAIN

We hereby declare under our responsibility, that the equipments identified below comply with the following specifications :

Series: Isolated Signal Converter of the ISC Series
Models : P, PT100, TJ, TK, TE, TT, TR, TS,
 VAC, VDC, IAC, IDC, POT, RES, HZ, LC

DIRECTIVES

EUROPEAN DIRECTIVE FOR LOW VOLTAGE D73/23/CEE AMENDED BY D93/68/CEE. Equipments powered from 50 to 1000 Vac and/or from 75 to 1500 Vdc.

EUROPEAN DIRECTIVE FOR PRODUCT SAFETY D92/59/CEE

ELECTROTECHNICAL REGULATION FOR LOW VOLTAGE (RBT) ITC21, ITC 29, ITC 35. For equipments with power supply lower than 50Vac and/or 75Vdc.

EUROPEAN DIRECTIVE FOR ELECTROMAGNETIC COMPATIBILITY D89/336/CEE AMENDED BY D93/68CEE, ACCORDING TO RD1950/1995 (01/12)

REGULATIONS

ELECTRICAL SECURITY: EN61010-1

SUSCEPTIBILITY: EN 50082-2

IEC 1000-4-2, EN 61000-4-2, IEC 801-2

ENV 50140, EN 61000-4-4, IEC 801-4 (level 3)

ENV 50204 (level 3)

EMISSION: EN 50081-2

EN 55011, EN 55014, EN 55022

UNE 21352-76: CEI 359-71

Operating quality expressions for electronic equipments.

UNE 20652-80: CEI 284-68

Behaviour rules inherent to the handling of electronic equipments and other similar technics.

Signed : D.Juncà

Quality Manager

Barberà del Vallès, 2002

10-CAUTIONS, WARNINGS AND NOTES

INSTALLATION

PRECAUTIONS.- The installation and the future use of this unit must be done by qualified personnel. The unit has not AC (mains) switch, neither internal protection fuse. It will be in operation as soon as power is connected. The installation must incorporate an external mains switch with a protection fuse and also the necessary devices to protect the operator and the process when using the unit to a control machine or process where injury to personnel or damage to equipment or process may occur as a result of failure of the unit.



RECOMMENDED FUSES

24Vdc	230Vac	115Vac
250mA	70mA	100mA
Time-lag	Time-lag	Time-lag

SAFETY PRESCRIPTIONS.- The unit has been designed and tested under EN-61010-1 rules and is delivered in good conditions. This User's Manual contains useful information the user has to respect in order to warrant a proper function of the unit, and good security conditions. The unit is designed for internal applications, with good ventilation to avoid excessive heating. It can **occasionally** be applied to temperatures down to 10°C or up to 70°C without security degradation. Do all connections before applying power to the unit. Do not make wiring changes until power is disconnected from the unit.



Install the unit far from elements generating electric noise, or magnetic fields, such as power relays, electrical engines, speed regulators, etc. Do not use until installation is completed.

POWER SUPPLY.- The power supply must be connected to the adequate terminals 1, 2 and 3. The characteristics of the power supply are shown on the side label. Please make sure that the unit is correctly connected to a power supply of the correct voltage and frequency. Do not connect the unit to lines which are overloaded or which provide power to systems working on ON-OFF cycles or inductive loads.

ATTENTION

For instruments which are DC powered, respect the polarity of the power terminals as indicated on this user's manual, and on the instrument itself.

SIGNAL WIRING .- Certain considerations must be given when installing the signal input wires. If the wires are long, they can act as an antenna introducing electrical noise into the unit. Therefore :

- Do not install the signal input wires in the same conduit with power lines, heaters, solenoids, SCR controls, etc ... and always far from these elements.
- When shielded wires are used, leave unconnected the shield on the transmitter side and connect the other end of the shield to the ground terminal of the machine.

EXCITATION VOLTAGE

Model ISC-P incorporates an internal power supply for transducers. The output of this power supply is connected to terminals 7 and 9. Do not connect these terminals to an external power supply, because both units will be permanently damaged.

SAFETY CONSIDERATIONS

PRESCRIPTION.- Before starting any operation for replacement, maintenance or repair, the unit must be disconnected from any kind of power supply.



Keep the unit clean, to assure good functioning and performance. To prevent electrical or fire hazard, do not expose the unit to excessive moisture. Do not operate the unit in the presence of flammable gases or fumes, such an environment definitely constitutes a safety hazard. The unit is designed to be mounted on a metal panel.

If the unit shows signs of damage, is not able to show the expected measures, has been stored in a bad conditions or a protection failure happened, then do not attempt to operate, keep the unit out of service and send for repair.

IN CASE OF FIRE

- 1.- Disconnect the unit from the power supply
- 2.- Give the alarm according to the local rules
- 3.- Switch off all air conditioning devices



- 4.- Attack the fire with carbonic snow, do not use water in any case

WARNING: In closed areas do not use systems with vaporized liquids.

11-WARRANTY

FEMA ELECTRÓNICA, S.A. warrants this unit to be free of manufacturing defects for a period of 24 MONTHS from shipment date. This warranty covers both materials and manufacturing processes.

This warranty is VOID if the unit shows evidence of damages as a result of misapplication, accident, misuse or if the product had been tampered or repaired by personnel or companies without the official authorization of **FEMA ELECTRÓNICA, S.A.** This warranty is also VOID for damages caused by defective or inappropriate applications.

RETURNS FOR REPAIR

Ship free of charges and properly packed to the address indicated below :

FEMA ELECTRÓNICA, S.A.

Pol.Ind.Santiga - Altimira 14 (T-14 N-2)
E-08210 Barberà del Vallés - BARCELONA
ESPAÑA - SPAIN

In case of malfunction, the unit should be sent to the manufacturer for its evaluation. Within the warranty period, and always previous examination from **FEMA ELECTRÓNICA, S.A.**, the unit will be repaired or replaced to the discretion of the manufacturer.

Limitation of liability : **FEMA ELECTRÓNICA, S.A.** shall not be responsible for any damage or loss to other equipment however caused, which may be experienced as a result of the installation or use of this product. **FEMA ELECTRÓNICA, S.A.** liability shall not exceed the purchase price paid of the product upon which liability is based. In no event shall **FEMA ELECTRÓNICA, S.A.** be liable for consequential, incidental or special damages

other products



Programmable
Panel Meters



Signal Converters &
Isolated Transmitters



Large Displays



Standard
Panel Meters



Miniature
Panel Meters



Large Displays
for TIME

www.fema.es

ELECTRONIC INSTRUMENTATION FOR INDUSTRY

FEMA ELECTRÓNICA, S.A.

Pol. Ind. Santiga - Altimira 14 (T14 - N2)
E-08210 Barberà - BARCELONA
ESPAÑA - SPAIN

Tel. (+34) 93.729.6004 - www.fema.es
Fax (+34) 93.729.6003 - info@fema.es