

EMC-D3b

ENERGY MULTIFUNCTION COUNTER

EMC-D3b-485

AVAILABLE MODELS

EMC-D3b: 3-phase energy counter with 7+1 digit display. 1 digital input and two digital pulse output for kWhr and kVAhr.

EMC-D3b-485: 3-phase energy counter with 7+1 digit display, 1 digital input, two digital pulse output for kWhr and kVAhr, EIA-RS485 serial communication port, Modbus RTU protocol.

Both are manufactured in DIN rail mounting case 6 modules 17.5 mm.

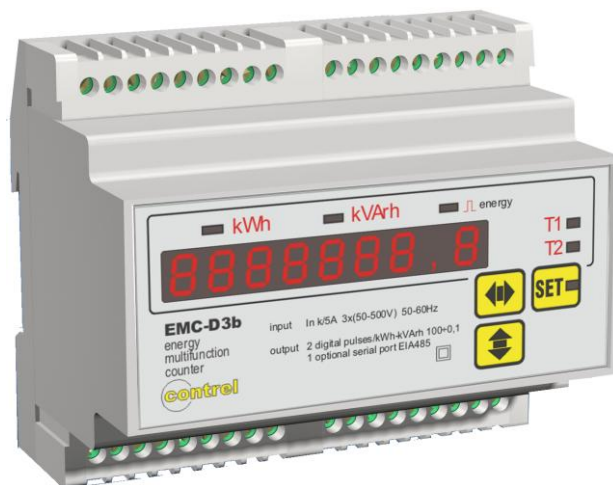

INTRODUCTION

The EMC-D3b models allows the local or remote counting of the energy, with the help of a serial interface.

It is possible to set the instrument to count in 3 differents mode (Normal / Total and partial / Timeband).

Also the instrument is equipped with a digital input which can cover differents function. See the **digital input** section for more information.

The auxiliary power supply is taken from same Voltage inputs (VL1 and VL2), used for measuring. It's available as option the instrument for single phase networks.

OPTIONS and ACCESSORIES

- options:**
- internal CT's (**not for direct line insertion**) (order with -t suffix)
 - current inputs for ... /1A current transformer (order with /1A suffix)
 - current sensor for low current measures (Max 15 Amp) (specify when ordering)
 - power supply and measuring voltages other than the standard (specify when ordering)
 - power supply separated from measuring voltage (specify when ordering)
 - single phase network (power supply is taken from VL1 and neutral) (specify when ordering)

MEASURED PARAMETERS

Parameters showed in counter mode	Unit of measure	Identifying abbreviations
three phase system active energy	[kWhr]	kWh
three phase system reactive energy	[kVAhr]	kVAhr
three phase system apparent energy	[kVAhr]	kVAh
Parameters showed in meter mode	unit of measurement	initial identification
phase voltages	[V-kV]	V _{L1-N} V _{L2-N} V _{L3-N}
phase to phase system voltages	[V-kV]	V _{L1-L2} V _{L2-L3} V _{L3-L1}
phase currents	[A-kA]	A _{L1} A _{L2} A _{L3}
phase power factors		PF _{L1} PF _{L2} PF _{L3}
phase active powers	[W-kW-MW]	W _{L1} W _{L2} W _{L3}
phase reactive powers	[VAr-kVAr-MVAr]	VAr _{L1} VAr _{L2} VAr _{L3}
phase apparent powers	[VA-kVA-MVA]	VA _{L1} VA _{L2} VA _{L3}
frequency	[Hz]	Hz _{L1}

These parameters are available only on EMC-D3b-485 model and readable only by RS485 interface.

Peak, average and max demand value	unit of measurement	Initial identification
maximum phase voltages	[V-kV]	V _{L1-N max} V _{L2-N max} V _{L3-N max}
maximum phase currents	[A-kA]	A _{L1 max} A _{L2 max} A _{L3 max}
maximum three-phase powers	[W-VAr-VA (k-M)]	Σ W _{max} Σ VAr _{max} Σ VA _{max}
maximum average phase currents (maximum demand)	[A-kA]	I _{L1 max (avg)} I _{L2 max (avg)} I _{L3 max (avg)}
maximum average three-phase powers (maximum demand)	[W-VAr-VA (k-M)]	Σ W _{max (avg)} Σ VAr _{max (avg)} Σ VA _{max (avg)}
average phase currents	[A-kA]	A _{L1 avg} A _{L2 avg} A _{L3 avg}
average three-phase powers	[W-VAr-VA (k-M)]	Σ W _{avg} Σ VAr _{avg} Σ VA _{avg}

INSTALLATION

Warnings for the users

Read carefully the instructions in this manual before installing the present instrument.
The instrument described in this manual is intended for being used only by properly trained staff.

Safety

This instrument has been manufactured and tested according to EN 61010-1 standards. In order to maintain these conditions and to ensure safe operation, the users must follow the instructions of this manual.

When the instrument is received, before beginning installation, check that it's still intact and no damage has been suffered during transport. Before starting installation make sure that the operating voltage and mains voltage are compatible with the device instructions.

The instrument power supply must not be earthen. Only qualified and authorised staff must carry out maintenance and/or repair. Should it be considered that there is a safety loss during operation, the instrument must be disconnected and precautions taken against accidental use.

Operation is no longer safe when: - The instrument doesn't work. / - The measured value are obviously wrong or unreasonable / - There is clearly visible damage. / - After serious damage incurred during transport. / - After a storage under unfavourable conditions.

An external protection should be foreseen, by means of a 0.5 A 250V fuse at the voltage inputs. Use adequate cables for the working current and voltage, with a cross section of 0.5 to 2.5 mm².

CONNECTION

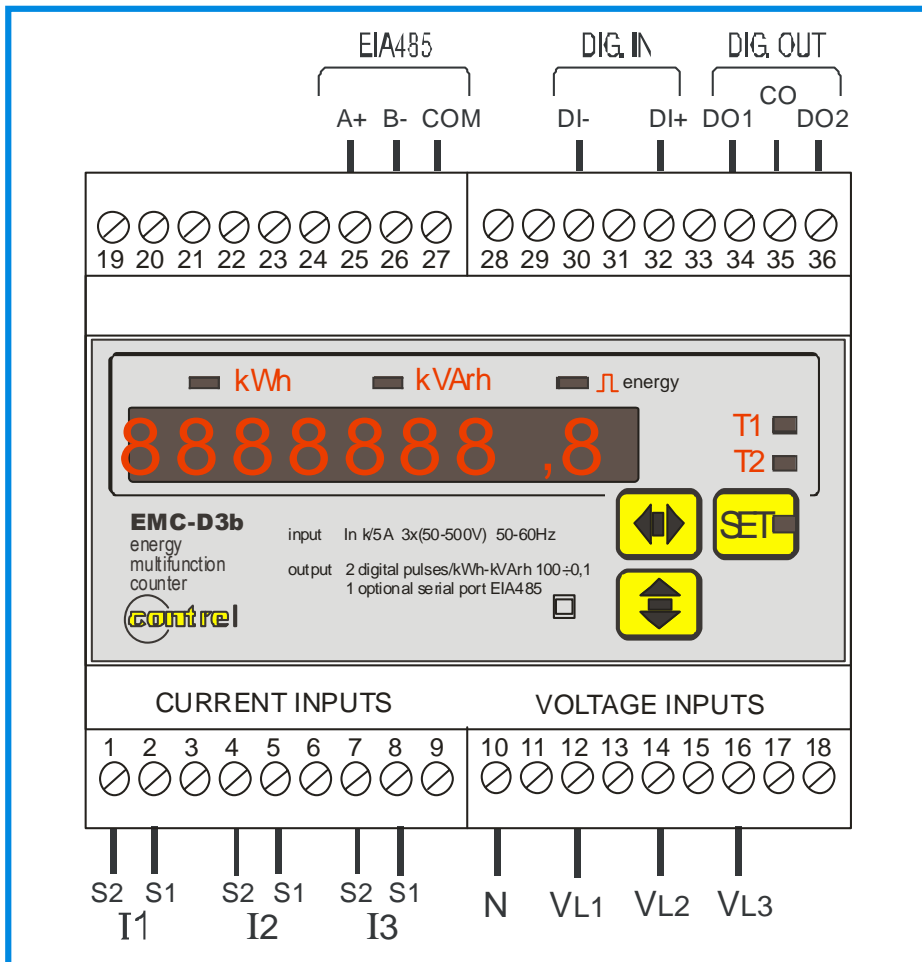

For a correct use of the device, the wiring diagram contained in the present manual, must be respected.
The connections are available on the screw terminal:

- auxiliary power supply:

The power supply is take from voltage inputs.

Are available 5 different auxiliary supply:

0 - 115V = 100-130V 50-60Hz (N-L1) (on request by single phase option)

0 - 230V = 220-240V 50-60Hz (N-L1) (on request by single phase option)

0 - 400V = 380-415V 50-60Hz (L1-L2) standard model

0 - 230V = 220-240V 50-60Hz (L1-L2) (on request)

0 - 115V = 100-130V 50-60Hz (L1-L2) (on request)

It's possible, for example, to give an auxiliary power supply between phase and neutral, in a 4 wires system, or phase-phase in a 3 wires system, without neutral or from a VT in a medium voltage application.

In the standard version the voltage is 400V and it's taken between the phases L1-L2.

In the following table it's possible to see the measurable voltage depending of the type of power supply.

power supply terminals	rated voltage	range of measurable voltage
VL1 - VL2 (phase to phase power supply for 3-phase networks)	400V	300÷500V phase to phase (175÷290V phase-neutral)
	230V	175÷290V phase to phase (130÷170V phase-neutral)
	110V	85÷145V phase to phase (50÷85V phase-neutral)
VL1-N (phase-neutral power supply for single phase networks)	230V	175÷290V phase-neutral
	110V	100÷170V phase-neutral

The standard version allows to apply the instrument at all the three-phase network 400V with or without neutral supplied. For example for application on single phase 230V will need the L1-N / 230V. while for applications in medium voltage (for example using external voltage transformer 15 / 0.1 kV phase to phase) will need the version L1-L2 / 110V.

- measuring voltage inputs:

4 screw terminals are available for the 3 phase plus neutral system network. The maximum voltage between phase to phase must not overcome 500 Vrms., depending always on the instrument's power supply.

In case of three phase application with or without neutral not distributed, it is enough not to connect the terminal N.

The transformation ratio of the external Potential Tranformer's can be set on the instrument's SETUP menu (see **SeT VT** ratio).

- measuring current inputs:

6 screw terminals are available for the connection of the external CT with secondary 5A. It is also possible to use 2 CT in a three phase system (3Phase Aaron wiring system).

It's compulsory to use external CT's.

The transformation ratio of the external CT's can be set on the instrument's SETUP menu.

NOTE: It's fundamental to respect the correct phase sequence. The connections between current and voltage phase inputs must not be inverted (for example, CT placed on phase L1 must correspond to the I1 input) and at the same time it's not correct to invert the S1 and S2 terminals considering that the energy metering won't be reliable.

- digital input

On the terminal board 30 (DI+) and 32 (DI-) is available the digital input.

This input can operate in three differents mode:

- Sync: can recognize pulse (minimum time = 200 mS) to synchronize the internal average period timer to an external device; this property is available with the energy count mode (refer to SETUP section) is set to 'TOTAL/PARTIAL' or to 'NORMAL';
- Reset when a voltage pulse of minimum 1 second is applied, perform the reset of the only PARTIAL energy counters of each energy type (kWhr, kVARhr, kVAhr); this property is available with the energy count mode (refer to SETUP section) is set to 'TOTAL/PARTIAL';
- Disabled No operation is done depending the digital input status.

When the energy count mode (refer to SETUP section) is set to 'TIME.BAND' the counting is divided in T1 or T2 band depending the status of digital input; SETUP of digital input is disabled;

Timeband T1 is selected when no voltage is applied, T2 when the input is powered

Each parameters (kWh, kVARh and kVAhr) have two counters T1 and T2, in which the energy is counted depending the status of digital input.

WIRING DIAGRAM
THREE-PHASE INSERTION

INSERTION ON THREE PHASE LINE WITH 3 OR 4 WIRES

on line with 3 wires (without neutral or with neutral not supplied) the N terminal must not be connected

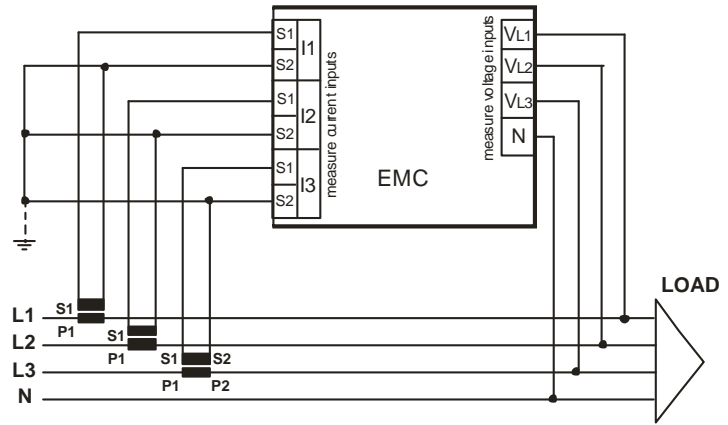

INSERTION ON THREE PHASE LINE WITH 4 WIRES AND 3 VT

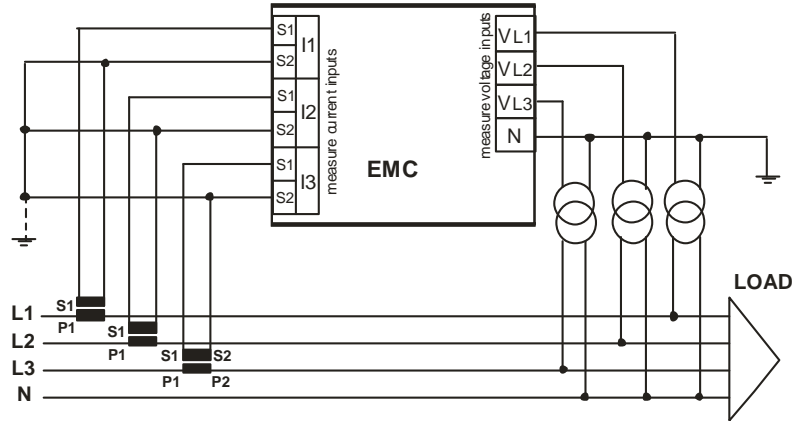

INSERTION ON THREE PHASE LINE WITH 3 WIRES AND 2 CT (insertion AARON)

*the voltage insertion with 2 VT is possible only for the version with internal CT

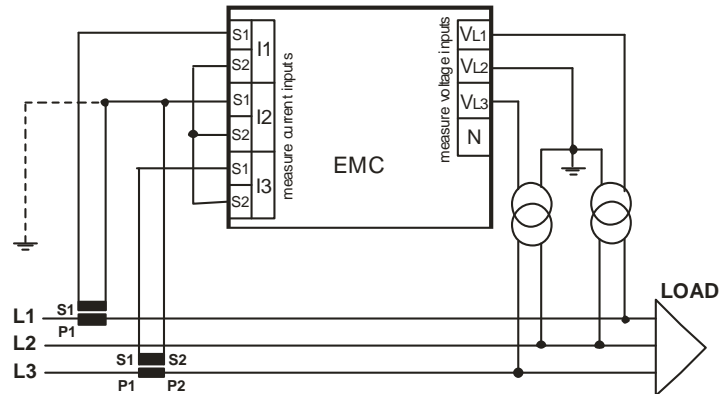

BALANCED THREE PHASE LINE

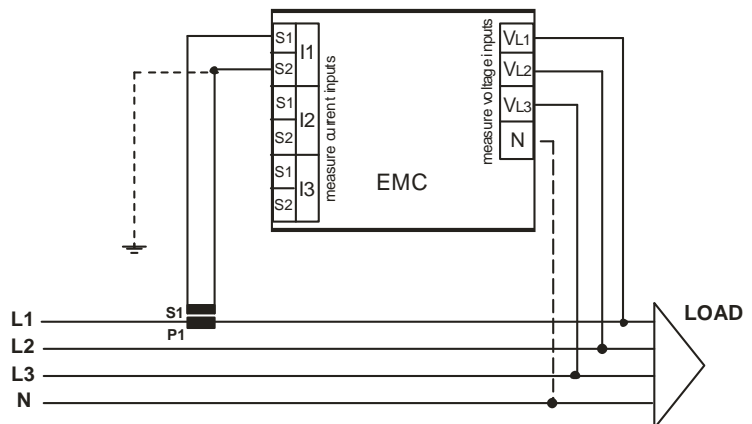

SINGLE-PHASE INSERTION

INSERTION ON SINGLE PHASE LINE

if the multimeters are used on single phase line, the measure are referred at the L1 phase.
The others data displayed relatives at value of three phase system are not to consider.

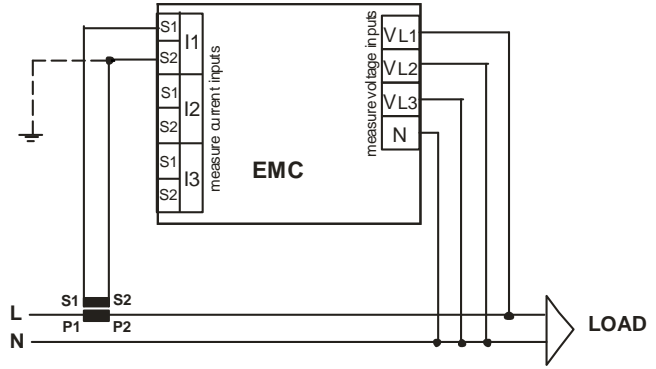

DIGITAL I/O

DIGITAL OUTPUTS

NOTE:
output DO1 for ACTIVE ENERGY pulses
output DO2 for REACTIVE ENERGY pulses

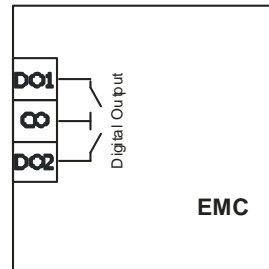

Max 150mA
Max 230Vac/dc

DIGITAL INPUT

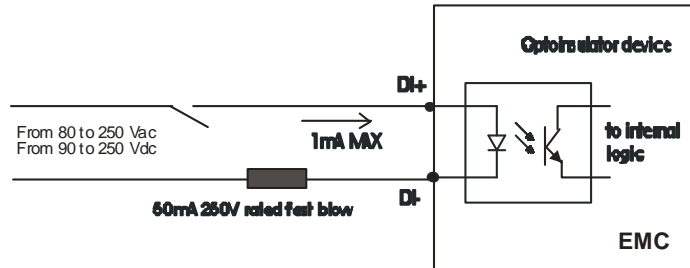

FRONT PANEL DESCRIPTION – KEYS

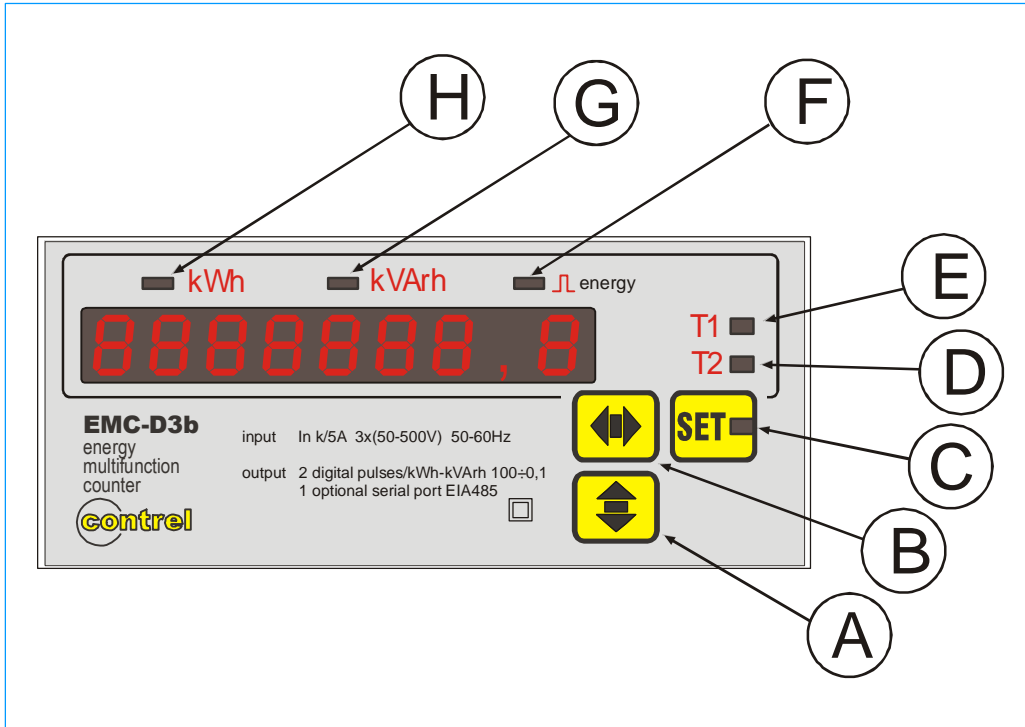

DESCRIPTION:

A: Push-button key for selecting the energy visualisation / for decreasing values when setting at SETUP.

B: Push-button key for selecting the energy visualisation / for increasing values when setting at SETUP.

C: Push-button key to reach the programming mode; the associated LED go on to advise that the SETUP mode is active.

NOTE: pressing both A key and B key for at least 5 second, the display change to visualize instantaneous measures (voltage, current and so on). Refer to section Measure Visualization.

D: LED for indication of the T1 time band energies. Should it be blinking, it means that the energy counting is being accumulated on time band 1.

E: LED for indication of the T2 time band energies. Should it be blinking, it means that the energy counting is being accumulated on time band 2.

F: LED indicating energy counting. The frequency of blinking is proportional to the energy displayed.

G: LED for indication of reactive energy counting.

H: LED for indication of active energy counting.

NOTE: when both LED G and H are OFF, is displayed the apparent energy counters.

INSTRUMENT'S PROGRAMMING MENU (SETUP)

By pressing the **C** key we get to the programming of the instrument.











































The programs, confirmed with the **C** key are kept memorised, whilst the performed modifications won't be kept memorised, if they have not been confirmed with the **C** key. Once that 16 seconds have elapsed from the last pressure to any key, the instrument comes back to energies visualisation.

The instrument's parameters can be programmed with the **SETUP** menu or either cancelling the energy counters with the **RESET** menu.

SET GENERAL PARAMETER (SET UP)

Entry to menu:  seT UP →

 seT Up
RESETE
COM 485

		CT Set CT ratio from 1 to 3000		Increase
		VT Set VT ratio from 0.1 to 400.0	 	Decrease Increase
		Set Energy count mode	 	Decrease E.NORMAL E.TOT.PAR
		TIME.BAND Set type of Digital Input	 	DI =T.SYNC Di =Reset DI =DI saB
		T.AVR Set average time From 1 to 30 minutes	 	Increase Decrease
		Set connection type	 	3PH.UNBAL 3ph.BALAN 1PH. L1-N
		Set wiring connection type	 	-3- -4-
		Set synchronism type	 	SYNC. 60 SYNC. 50 SYNC. L1
		PUL Set pulse weight	 	10.0 kW-kVAr / pulse 01.0 kW-kVAr / pulse 00.1 kW-kVAr / pulse 0.01 kW-kVAr / pulse
		TPL Set the duration pulse 300 mS 400 mS 500 mS	 	100 mS 200 mS
(only for EMC-D3b-485)		ID Set address of network from 001 to 247	 	Increase Decrease
Set baud rate serial interface (only for EMC-D3b-485)		BDR 19200 baud 9600 baud 4800 baud 2400 baud	 	19.2 9.60 4.80 2.40
Set parameters of Communication serial interface (only for EMC-D3b-485)		PAR bit: 8data 1stop-no parity bit: 8data 2stop-no parity bit: 8data 1stop-even parity bit: 8data 1stop-odd parity	 	8.1 NO 8.2 NO 8.1 EVE 8.1 ODD
		PAS Set Password OFF - 0002 ÷ 9999	 	Increase Decrease
		Confirm and end of general settings		
				

Programming of the transformation ratio of the external current transformers (CT)

The programming of the CT ratio, intended as the ratio between the primary and the secondary circuit (example: with CT 1000/5 it must be set 200), has to be performed by using the front keys.

After the enter in the setup (message **SETUP** on display) pressing the **C** key, on the display appears the message **CT** (Current transformer ratio) with the transformation ratio value (set to 1 by the manufacturer). Press **B** or **A** keys to increase or decrease the value respectively (the variation is performed unit by unit). In order to speed up the operation, keep the **B** or **A** key pressed, the variation will be performed by tens and hundreds. To increase or decrease the value by unit, it is necessary to release and to press the button again. To confirm the set value, press the **C** button; in this way it is possible to enter the next programming. If none key is pressed for 16 seconds, the instrument will automatically leave the programming menu and the eventual setting SHALL NOT be stored.

NOTE: in instruments with option ../1A current input, the maximum CT transformer ratio is set to 9999.

Programming of the transformation ratio of the external voltage transformers (VT)

After the precedent programming phase, on display will appear the inscription **VT** (voltage transformer) and the value of the transformation rate of the external TV (set to 1 from the constructor), considered as the rate between primary and secondary (example with TV 15/0.1 kV the value will be 150). In the same way at the programming of the CT rate will be possible to set this value. If the external TV are not used the value to set will be 1. To confirm the value press the **C** button.

Programming of the Energy counter mode (E.NORMAL - E.TOT.PAR - TIME.BAND)

It's possible to set between the following type of Energy count:

- E.NORMAL** Only one counter is available for each energy; resetting the energies is available only by the front panel;
- E.TOT.PAR** Two counters are available for each energy; the total counters are not resettable and is displayed when the led T1 is ON; reset the partial counter is possible by the front panel or by the digital input (see **digital input** section and **Programming of the Digital Input type**)
- TIME.BAND** Two counters are available for each energy; the counted energy is totalized in T1 or T2 counter depending the status of digital input; resetting the energies make a reset of ALL the counters.

Pressing the **A** key, confirm and go away with the next setting.

Programming of the Digital Input type (DI =T.SYNC - DI= RESET - DI =DISAB)

It's possible to set between the following type of digital Input:

DI =T.SYNC

DI= RESET

DI =DiSAB

This setup is depending on the choice made in the previous **programming of the energy counter mode**
See the digital **input section** to more information.

Programming of the average time (seT AVR)

After the programming phase previously described, pressing another time the **C** key, on the display will appear the message **AVR** and the average time settable from 1 to 30 minutes.

To increase the value press the **B** key. To decrease it, press the **A** key. To confirm it press the **C** key.

The average time is the time used to calculate the average parameters (**avg**) and the maximum demand (**maxD**).

The average measures and max demand measures are readable only in the model with the serial port RS485 and only using the RTU Modbus protocol. For list of Modbus register please refer to the manual IM154.

Programming insertion mode

The possible insertion modes are:

3PH.UNB setting or three phase unbalanced system insertion

3PH.BALAN setting for three phase balanced system (only one CT and only one VT)

1PH L1-N. Setting for a single phase networks

Programming wiring connection mode

This setting allows to definite the wiring type connection. It's possible to chose 3 wires or 4 wires. With the 4 wires connection the neutral parameter are displayed and enabled to use for the digital and analog outputs settings.

Programming of the synchronism type

The possible choices are

SYNC.L1

SYNC.50

SYNC.60

Choose **SYNC.L1** to use the external frequency (taken from VL1 phase) as time reference for calculate frequency and other acquisition parameters;

choose **SYNC.50** or **SYNC.60** Hz to use the internal clock as time reference; this is useful when presence of heavy harmonics on the network cause defective frequency calculation.

Programming of the weight of the active and reactive energy pulse (PUL)

After the above mentioned programming, by pressing the **C** key again, the message **PUI** will appear on the display and the value of the weight of one pulse settable on three phase values: **0,01 - 0,1 - 1 - 10** kWh or kVAh (for each emitted pulse the instrument will have counted 0,01 - 0,1 - 1 - 10 kWh o kVAh).

Press the **B** key to increase the value or **A** key to decrease the value and **C** to confirm.

Programming of the duration pulse (TPL)

The message **TPL** will appear together the value of the duration pulse expressed in mS. It's possible to select the value from 100 mS to 500 mS, with 100 ms steps by using **B** key (to increase the value) and **A** (to decrease the value). Confirm the value pressing the **C** key.

This setting is used by all digital outputs.

If the instrument has not options the programming continues with the set password **PASS**, then it come back at the first page **SETUP**. The presence or the absence of the options, digital input and serial output, will allow the visualization or not of the other settings.

Programming of the address for the communication network (ID) (only for EMC-D3b-485)

After the confirm with the **C** key of the previous value, the message **ID** will appear on display; to set the value that will identify the instrument when it will be connected in a EIA485 communication network, proceed with the modality, already described. The settable values are from 1 to 247. To confirm, press the **C** key.

Programming of the baud rate (BDR) (only for EMC-D3b-485)

The following setting is the baud rate. The message **BDR** with the value on the display to indicate the programming of the baud rate. To modify the value set, it's necessary to use the **A** key to decrease and **B** to increase the rate. The values settable are:

- **19.2** => 19200 baud

- **9.60** => 9600 baud

- **4.80** => 4800 baud

- **2.40** => 2400 baud

Press **C** to confirm the value displayed.

Programming of the serial parameters (only for EMC-D3b-485)

On display will appear the message **SET**. The following message will appear on display using the **A** and **B** keys. To confirm press the **C** key.

8 1 8 data bit / 1 stop bit NO No parity	8 2 8 data bit / 2 stop bit NO No parity	8 1 8 data bit / 1 stop bit EVE Even parity	8 1 8 data bit / 1 stop bit ODD Odd parity
---	---	--	---

Programming of the Password (PAS)

The instrument is supplied without password. When a password (from 0002 to 9999) is set, using the **B** (to increase), **A** (to decrease) and **C** (to confirm) keys, only who know this value can to enter in the setup. The password, in fact, is required all the time that someone try to enter in the setup (pressing the **C** key). If the password is wrong, the message **PASS ERR** will appear on display and the instrument go back to the measures visualization. To input the password, when required by the instrument, at the enter of the setup, use the **A**, **B** and **C** keys as the same way done previously.

The menu is cyclic. After the last setting, the instrument go back to the first page of Setup (SETUP).

I/O INFO PAGE

The status of the serial port appear on the display when the instrument has this option. If the instrument receives data, it displays the letter R and the number of the instrument that is in communication while if the instrument transmits data, it displays the letter T.

MEASURES VISUALISATION

There are 2 mode of measure visualization: counter mode and meter mode:

Counter mode

In the counter mode (automatically selected at the power on and exiting from SETUP), the energies are visualised by a 7 + 1 digit display (kWhr/kVARhr/kVAhr)

According with the switching status of the LED's kWh, kVARh, T1 and T2, the various visualization mode are explained by the following tables:

Energy operating mode = E.NORMAL

Parameter	LED's STATUS			
	LED kWh	LED kVARh	LED T1	LED T2
Visualisation active energy	SWITCHED ON	SWITCHED OFF	ALWAYS OFF	ALWAYS OFF
Visualisation reactive energy	SWITCHED ON	SWITCHED ON	ALWAYS OFF	ALWAYS OFF
Visualisation apparent energy	SWITCHED OFF	SWITCHED OFF	ALWAYS OFF	ALWAYS OFF

Energy operating mode = E.TOT.PAR

Parameter	LED's STATUS			
	LED kWh	LED kVARh	LED T1	LED T2
Visualisation: <u>ACTIVE ENERGY</u> TOTAL counter	SWITCHED ON	SWITCHED OFF	SWITCHED ON	SWITCHED OFF
Visualisation: <u>ACTIVE ENERGY</u> PARTIAL counter	SWITCHED ON	SWITCHED OFF	SWITCHED OFF	SWITCHED ON
Visualisation: <u>REACTIVE ENERGY</u> TOTAL counter	SWITCHED OFF	SWITCHED ON	SWITCHED ON	SWITCHED OFF
Visualisation: <u>REACTIVE ENERGY</u> PARTIAL counter	SWITCHED OFF	SWITCHED ON	SWITCHED OFF	SWITCHED ON
Visualisation: <u>APPARENT ENERGY</u> TOTAL counter	SWITCHED OFF	SWITCHED OFF	SWITCHED ON	SWITCHED OFF
Visualisation: <u>APPARENT ENERGY</u> PARTIAL counter	SWITCHED OFF	SWITCHED OFF	SWITCHED OFF	SWITCHED ON

Energy operating mode = TIME.BAND

Parameter	LED's STATUS			
	LED kWh	LED kVARh	LED T1	LED T2
Visualisation active energy T1time band Energy counting on T1 time band	SWITCHED ON	SWITCHED OFF	BLINKING	SWITCHED OFF
Visualisation active energy T2time band Energy counting on T1 time band	SWITCHED ON	SWITCHED OFF	BLINKING	SWITCHED ON
Visualisation active energy T1time band Energy counting on T2 time band	SWITCHED ON	SWITCHED OFF	SWITCHED ON	BLINKING
Visualisation active energy T2time band Energy counting on T2 time band	SWITCHED ON	SWITCHED OFF	SWITCHED OFF	BLINKING
Visualisation reactive energy T1time band Energy counting on T1 time band	SWITCHED OFF	SWITCHED ON	BLINKING	SWITCHED OFF
Visualisation reactive energy T2time band Energy counting on T1 time band	SWITCHED OFF	SWITCHED ON	BLINKING	SWITCHED ON
Visualisation reactive energy T1time band Energy counting on T2 time band	SWITCHED OFF	SWITCHED ON	SWITCHED ON	BLINKING
Visualisation reactive energy T2time band Energy counting on T2 time band	SWITCHED OFF	SWITCHED ON	SWITCHED OFF	BLINKING
Visualisation apparent energy T1time band Energy counting on T1 time band	SWITCHED OFF	SWITCHED OFF	BLINKING	SWITCHED OFF
Visualisation apparent energy T2time band Energy counting on T1 time band	SWITCHED OFF	SWITCHED OFF	BLINKING	SWITCHED OFF
Visualisation apparent energy T1time band Energy counting on T2 time band	SWITCHED OFF	SWITCHED OFF	SWITCHED OFF	BLINKING
Visualisation apparent energy T2time band Energy counting on T2 time band	SWITCHED OFF	SWITCHED OFF	SWITCHED OFF	BLINKING

Meter mode

The meter mode can be selected from the counter visualization mode, holding keys 'A' and 'B' for at least 5 second.

Measure are displayed on the right side of display, in 3-digit format

On the left side are displayed the name of parameter measured.

To change the parameter, press the keys 'A' or 'B'.

Leds status are don't care; only the pulse led show the status of last selected energy.

To revert to the visualization in counter mode you can hold keys 'A' and 'B' for at least 5 second or enter in SETUP and wait the automatically exit to counter visualization measure.

The following table is the list of parameter displayed in meter mode.

Measure visualization in meter mode

Parameter	Display
VOLTAGE VL1-NEUTRAL.	VI1 000
VOLTAGE VL2-NEUTRAL.	VI2 000
VOLTAGE VL3-NEUTRAL.	VI3 000
CURRENT PHASE L1	II1 000
CURRENT PHASE L2	II2 000
CURRENT PHASE L3	II3 000
POWER FACTOR PHASE L1.	PF1 000
POWER FACTOR PHASE L2.	PF2 000
POWER FACTOR PHASE L3.	PF3 000
ACTIVE POWER PHASE L1.	PL1 000
ACTIVE POWER PHASE L2.	PL2 000
ACTIVE POWER PHASE L3.	PL3 000
REACTIVE POWER PHASE L1.	QL1 000
REACTIVE POWER PHASE L2.	QL2 000
REACTIVE POWER PHASE L3.	QL3 000
APPARENT POWER PHASE L1.	SL1 000
APPARENT POWER PHASE L2.	SL2 000
APPARENT POWER PHASE L3.	SL3 000
VOLTAGE VL1 VL2.	V12 000
VOLTAGE VL2 VL3.	V23 000
VOLTAGE VL3 VL1.	V31 000
FREQUENCY L1	FRE 000

NOTE regarding to the measures.

In some applications, in which the CT's secondary is connected to other instruments, different of the EMC-D3b counters, there might be some measuring problems, depending on the typology of the current inputs. Optionally, there are alternatives adapted to solve these possible problems.

Please get in touch with the Technical Assistance Dpt., in case of problems.

NOTE regarding digital inputs.

It is advisable to place a fast fuse 50mA 250V at the digital input.

The maximum absorbed current is 1 mA.

In absence of voltage at the input, the T1 time band will be selected.

With voltage applied to the input, the T2 time band will be selected.

Please refer to the technical characteristics for further information's regarding the digital inputs.

TECHNICAL CHARACTERISTICS

MEASURES, ACCURACY	
Energy	Active, reactive and apparent energy in the three-phase system, with subdivision in two time bands Measuring range: 0 – 99999999,9 kWh (kVAh) Class 2 CEI EN62053-21 – CEI EN62052-11
POWER SUPPLY, MEASURING INPUTS	
Auxiliary power supply	Standard 380-415V \pm 15% Frequency 50-60Hz - absorption 3VA Voltage taken from voltage measuring inputs VL1 VL2
Voltage inputs	From 20 – 500 Vrms phase to phase (depending on the voltage power supply) ; permanent overload +20% - input impedance of 1 M Ω Wiring in three-phase systems, with 3 or 4 wires; single phase (option).
Current inputs	From 0,02 to 5A; permanent overload 30% - with external CT's with secondary 5A, primary programmable from 5 to 10000A - self-consumption <0,5VA
INPUTS / OUTPUTS	
Digital outputs	Two outputs with common, optomos 12 \div 230Vac/dc, max 150mA, Pulse Function: Weight programmable 0,01-0,1-1-10 kWh/pulse Pulse duration 100-200-300 400 500 milliseconds selectable dO1: active energy pulse output dO2: reactive energy pulse output
Digital Input	Changing time band function Optoisolated input: Insulation: 2500 Vrms 60 seconds Impedance: 440 kohm OFF voltage range - From 0 to 20 V ca/cc ON voltage range - From 80 Vac to 250 Vac, 50/60Hz - From 90 Vdc to 300Vcc, polarised.
Serial output	Only for EMC-D3b-485: one RS485 port, 2400 to 19200 baud's, MODBUS-RTU protocol
GENERAL	
Display, operation keys	1 display with red LED's of 7,5 mm, made by 8 digits of 7 segments 6 LED's of 3mm, for indicating about the visualisation mode 3 push-button keys for selecting measures and programming
Mechanics	Protection degree: IP52 frontal - IP20 casing and terminals - weight: 0,5 kg approx. Connections made through screw terminals for cross section wires of 2,5 mm ² Self-extinguishing plastic enclosure (Casing) for DIN rail 35mm mounting, with dimensions of 6 modules of 17,5mm.
Environmental	Working temperature: -10 \div 60°C; relative humidity <90% Stocking temperature: -25 \div 70°C Insulation test: 3 kV during 1 minute
Standards of reference and Marking	CEI EN 50081-2; CEI EN 61000-6-2; CEI EN 61010-1; CEI EN62053-21; CEI EN62052-11 

DIMENSIONS

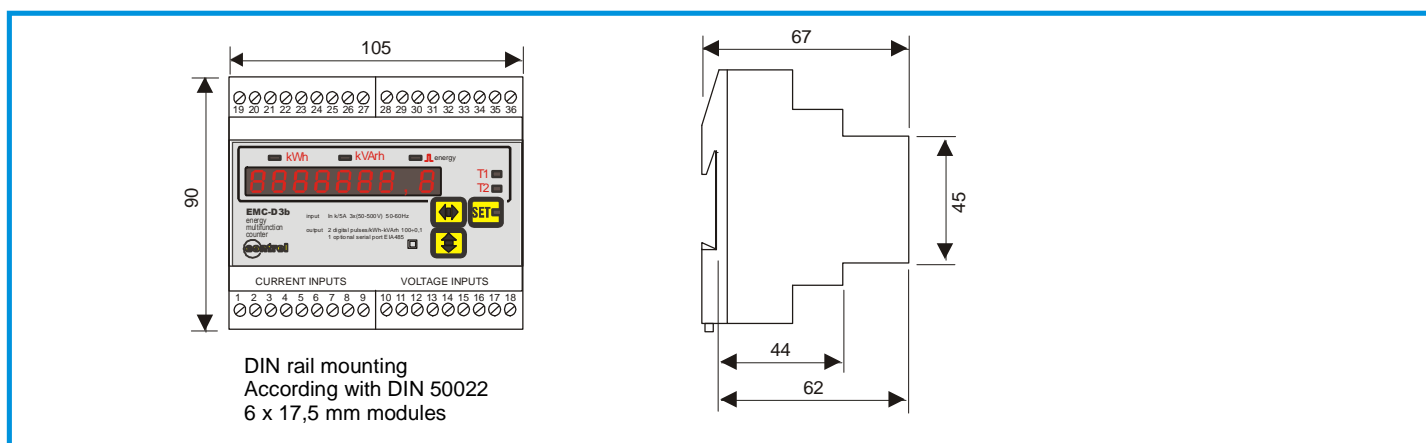

For applications that have not been described within the present manual, please refer to the specific documentation or contact with the Technical Assistance Department.

 **contrel** elettronica srl

I-26900 Lodi - ITALY - Via S. Fereolo, 9
Tel. +39 0371 30207 / 30761 Fax +39 0371 32819
<http://www.contrel.it> - E-mail: contrel@contrel.it