



Main characteristics

- Absolute measurement of position and speed
- Interface CANopen DS-301 V4.01 Device Profile DS-406 V2.0
- Strokes from 50 to 4000 mm
- Wide range of connectors for the electrical connection
- Position resolution up to $2\mu\text{m}$
- Speed resolution up to $0,01\text{mm/sec}$
- Rod, nipple, exagonal flange AISI 316
- Work temperature: $-30^{\circ}\dots+75^{\circ}\text{C}$
- Resistance to vibrations (DIN IEC68T2/6 12g)

The IK4 CANopen integrates a microprocessor to process the measurement and to diagnose the transducer. The CAN field bus communication system provides fast and safe transmission. The use of CANopen DS-301 protocol and Device Profile DS-406 provides quick and easy integration of the transducer in the control and automation system.

The IK4 line's new mechanical structure offers improved features for in-cylinder use, including a series of new multi-connector models, free rotation of the connector head, and replacement of internal electronics without removal of the transducer.

TECHNICAL DATA

Model	from 50 to 4000 mm
Measurement taken	linear position and speed
Position read sampling time	1 ms (depending on length)
Shock test DIN IEC68T2-27	100g - 11ms - single blow
Vibration DIN IEC68T2-6	12g / 10...2000Hz
Shift speed	$\leq 10\text{ m/s}$
Max. acceleration	$\leq 100\text{ m/s}^2$ shift
Resolution	$5\mu\text{m}$ ($2\mu\text{m}$ on request)
Cursor	Floating magnet
Work temperature	$-30\dots+75^{\circ}\text{C}$
Storage temperature	$-40\dots+100^{\circ}\text{C}$
Coefficient of temperature	$20\text{ppm F.S./}^{\circ}\text{C}$
Protection	IP67
Operative pressure	350 bar (pic max. 500 bar)

ELECTRICAL DATA

Output signal (respect to connection side)	Digital communication CAN bus
Nominal power supply	$24\text{ Vdc} \pm 20\%$
Max. power ripple	1 Vpp
Max. input	100 mA tipico
Electrical isolation	500 V (D.C. power supply/ground)
Protection against polarity inversion	Yes
Protection against overvoltage	Yes

MECHANICAL DIMENSIONS

Version IK4-C-B/X

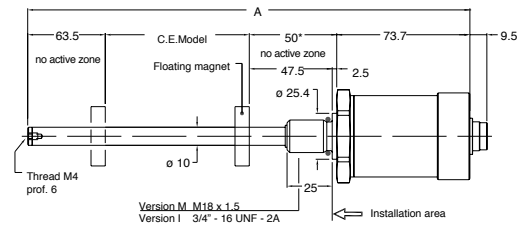

Version IK4-C-A/Y

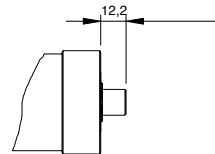

Version IK4-C-F

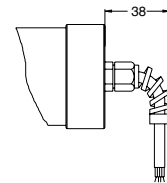

Version
IK4-C-A

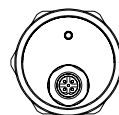

Version
IK4-C-Y

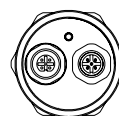

Version
IK4-C-B

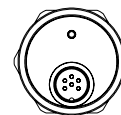

Version
IK4-C-X

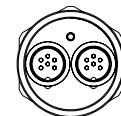

Version
IK4-C-F



ELECTRICAL / MECHANICAL DATA

Model		50	100	130	150	200	225	300	400	450	500	600	700	750	800	900	1000	1250	1500	1750	2000	2250	2500	2750	3000	3250	3500	3750	4000
Electrical stroke (E.S.)	mm	Model																											
Independent linearity	± %F.S.	Typical 0,02 (Max. 0,04)																											
Max. dimensions (A)	mm	Model + 187.20																											
Repeatability	mm	< 0,01																											
Hysteresis	mm	< 0,01																											
Sampling time	ms	1 for stroke from 0 to 1200mm; 2 for stroke from 1200 to 2400mm; 4 for stroke from > 2400mm																											

ELECTRICAL CONNECTIONS

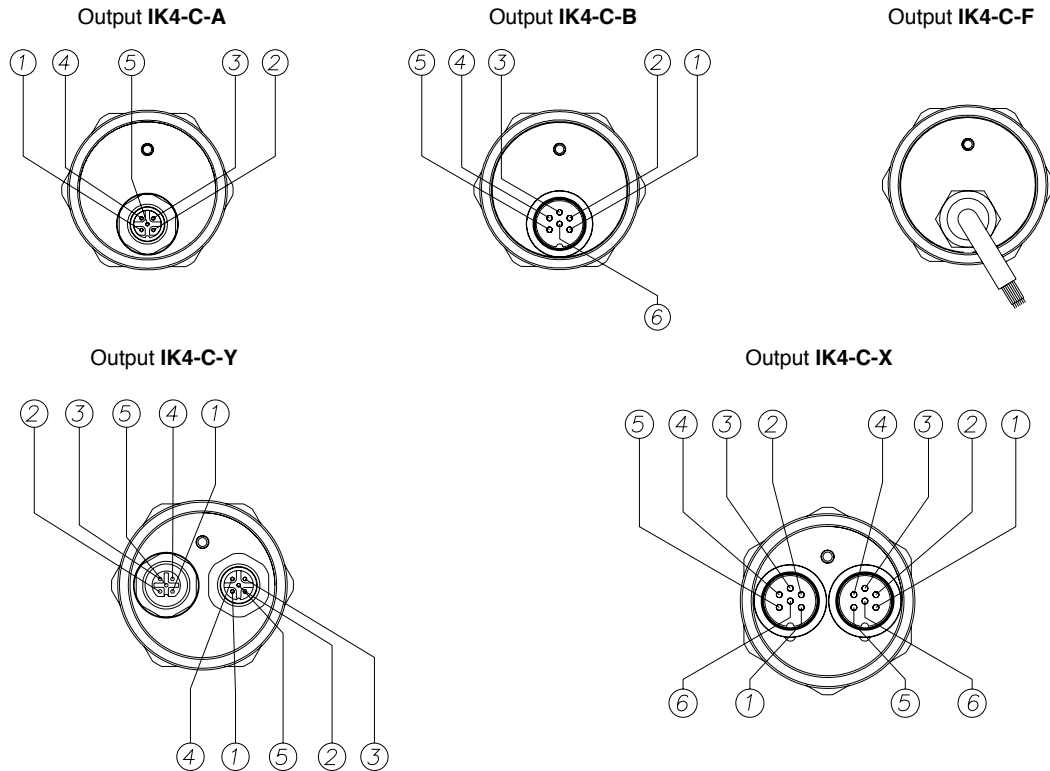

Function	CONNECTORS						CAVO
	IK4-C-A	IK4-C-B	IK4-C-Y		IK4-C-X		IK4-C-F
	5 pin M12	6 in M16	Double connector 5 pin M12 (male + female)		Double connector 6 pin M16 (male + female)		Standard cable 4 pin
			male	female	male 1	male 2	
CAN L	5	1	5	5	1	1	Blue
CAN H	4	2	4	4	2	2	White
CAN GND (n.c.)	1	3	1	1	3	3	-
n.c.	-	4	-	-	4	4	-
Power supply +	2	5	2	2	5	5	Red
Power supply GND	3	6	3	3	6	6	Black

GROUNDING IK4

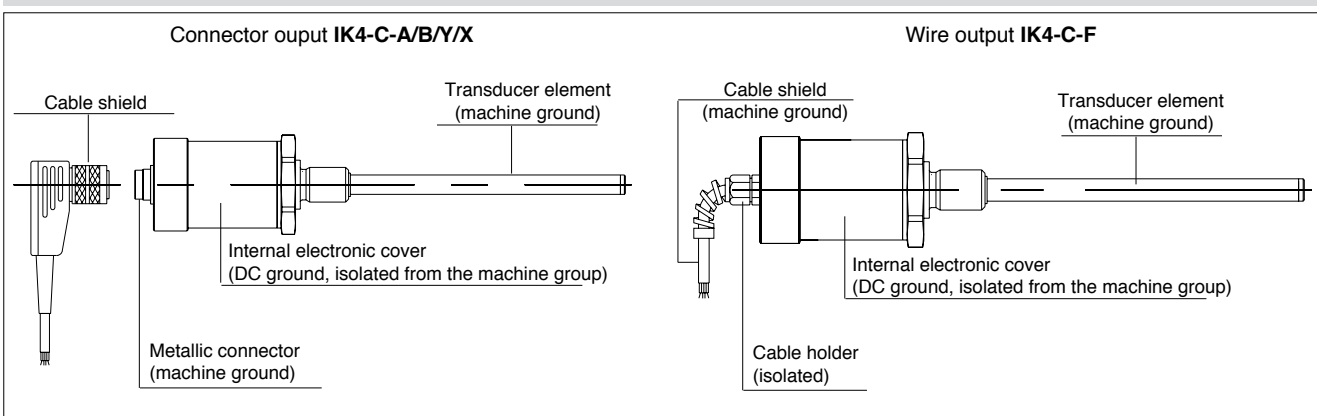

MOUNTING INSIDE A CYLINDER

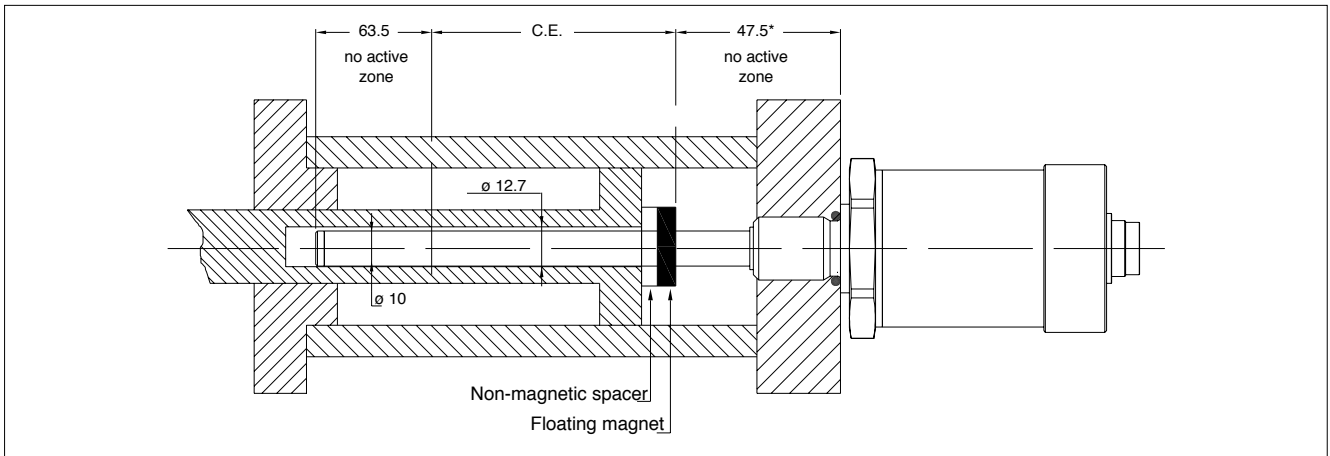

ORDER CODE

Position transducer I K 4 C [] [] [] [] [] []

CANopen interface	C
Output Connector	
M12 5 pin output connector	A
6 pin DIN 45322 output connector	B
M12 5 pin output duple connector	Y
DIN 45322 6 pin output duple connector	X
PVC 4 pin 7 x 0.25 output cable	F
MODEL	
Type	
See table 1	
Transmission speed	
See table 2	

Ex.: IK4-C-B-0400-A-3 0000-2-XXXX-00-M-0-XX
 Transducer model IK4, CANopen output, connector 6 pin, model 400mm, one cursor, transmission speed 500KBaud, Thread M18x1,5

Table 1

Type	N. cursors	PD01	PD02	PD03	PD04
A	1	Position Speed Cams	Absence of data	Absence of data	Absence of data
B	2	Position 1 Speed 1 Cams 1	Position 2 Speed 2 Cams 2	Absence of data	Absence of data

Position = 4 Byte whole - Speed = 2 Byte whole - Cams = 1 Byte whole

Table 2: transmission speed

1 = 1 Mbaud	4 = 250 kBaud	7 = 50 kBaud
2 = 800 kBaud	5 = 125 kBaud	8 = 20 kBaud
3 = 500 kBaud	6 = 100 kBaud	9 = 10kBaud

Transmission speed as function of cable length

Lunghezza cavo (m)	Baud Rate (KBaud)	Lunghezza cavo (m)	Baud Rate
< 25 m	1000	< 500 m	125
< 50 m	800	< 1000 m	100
< 100 m	500	< 1250 m	50
< 250 m	250	< 2500 m	20/10

Can Open Data Protocol

SOF	Arbitration	Control	Data Field	CRC	ACK	EOF	Interframe Space
1	11	1	6	0-8 Bytes	15	1 1 1	7
							≥ 3 Bits

Included in the supply

- Series IK position transducer
- OR 15.4 x 2.1 thread M18 x 1.5
- OR 16.36 x 2.21 thread 3/4" -16 UNF

GUA064
GUA065

► **Magnetic cursors must be ordered separately**

Mechanical and/or electrical characteristics differing from those in the standard version may be arranged on request.

CODE EXTENSION

[0] [0] [0] [0] [] [] [X] [X] [X] [] [] [] [] [] [X] [X]

System resolution
 1 = 0.002 mm
 2 = 0.005 mm (standard)
 3 = 0.010 mm
 4 = 0.020 mm
 5 = 0.040 mm

Node number programmer
 XXX = standard; node = 127
 nnn = Node number specified in order (001...126)

Cable lengths
 Output F 00 = 1mt 02 = 2mt 03 = 3mt 04 = 4mt
 05 = 5mt 10 = 10mt 15 = 15mt
 Output A/B/C 00

Thread
 M = M 18x1.5 (standard)
 I = 3/4" - 16UNF

Termination resistance
 0 = Without resistance
 1 = Resistance 120Ω

FLOATING CURSOR

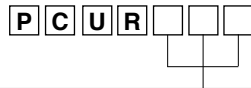

Cursors	
Cursor Diameter 32.8	022
Cursor Diameter 32.8 with 90° slit	023
Cursor Diameter 25.4	024
Floating cursor for liquids with hole diameter 12	026
Floating cursor for liquids with hole diameter 15	027

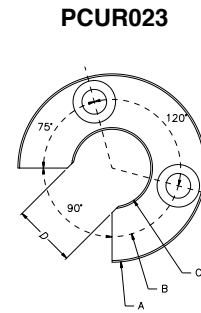
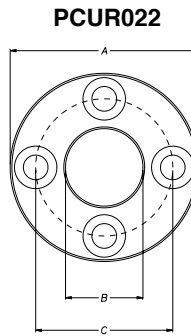

The **PCUR022** is supplied with: The **PCUR023** is supplied with:

N° 8 Brass nuts M4
N° 8 Brass washers D4
N° 4 Brass screws M4x25

N° 4 Brass nuts M4
N° 4 Brass washers D4
N° 2 Brass screws M4x25

Dimensions	A	B	C	Thickness
PCUR022	32.8	13.5	23.9	7.9
PCUR023				
PCUR024	25.4	13.5	-	

Model		PCUR026	PCUR027
Length A	mm	52.4	
Diameter B (hole)	mm	12	15
Diameter C	mm	42	
Material		AISI 316	

Note: **PCUR026** and **PCUR027** is supplied with kit **PKIT036** for floating cursor for liquids.

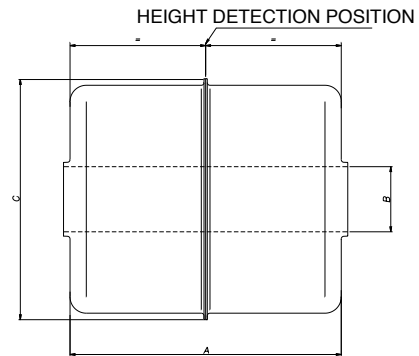
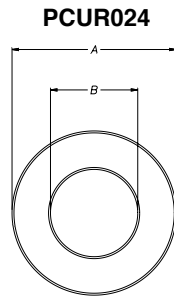

OPTIONAL CONNECTORS

For **IK4-C-A-Y** M12 thread connector

Code: **CON031** 5 pin
CON041 5 pin

For **IK4-C-B/X** M16 thread connector

Code: **CON021** 6 pin
CON022 6 pin
CON023 6 pin

Connector extraction length: 10mm

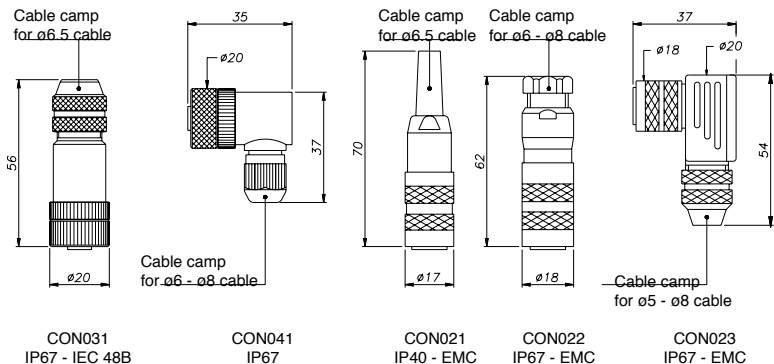

OPTIONAL CABLES OUTPUT

For **IK4-C-A**, cable with connector (straight or 90°) with M12 thread

Length "L"		CODE	
		Straight cable	Cable to 90°
2	mt	CAV011	CAV021
5	mt	CAV012	CAV022
10	mt	CAV013	CAV023
15	mt	CAV015	CAV024

ACCESSORIES (to order separately)

on-magnetic spacer for mounting PCUR022 cursor

Sensors are manufactured in compliance with:

- EMC 2014/30/EU compatibility directive
- RoHS 2011/65/EU directive

Electrical installation requirements and Conformity certificate are available on our web site: www.gefran.com

GEFRAN spa reserved the right to make aesthetic or functional changes at any time and without notice.

GEFRAN

GEFRAN spa
via Sebina, 74
25050 PROVAGLIO D'ISEO (BS) - ITALIA
ph. 0309888.1 - fax. 0309839063
<http://www.gefran.com>

DTS_IK4C_02-2017_ENG