



Main characteristics

- Absolute transducer
- Strokes from 50 to 4000mm (RK-4-_____-N/E/R)
- Direct analog output (RK-4-_____-N/K/E)
- Reverse analog output (RK-4-_____-R)
- Operating temperature: -30...+90°C
- Resistance to vibration (DIN IEC68T2/6 20g)
- Power supply 18Vdc...30Vdc
- Optional 12Vdc power supply (RK-4-_____-K)

Contactless linear position transducer with magnetostrictive technology: the absence of electrical contact on the cursor eliminates problems of wear and consumption and guarantees almost unlimited life.

The reduced dead zones and the head's threaded shape and small size make the RK-4 series ideal for applications requiring the installation of the transducer partially inside the hydraulic cylinder as a simplified alternative compared to the models of the IK4 series.

The overall dimensions of the sensor are among the smallest available on the market.

For what concerns the output signal, the analog interface gives the displacement of a single cursor (available in the several ranges in Voltage or Current).

Excellent linearity, repeatability, resistance to mechanical vibrations and shocks complete the product's specifications overview.

TECHNICAL DATA

Model	from 50 to 4000 mm (max. 1200 mm RK-4-_____-K)
Measurement taken	Displacement
Position read sampling time (typical)	1 ms
Shock test DIN IEC68T2-27	100g, 11ms single shock
Vibrations DIN IEC68T2-6	20g, 10...2000Hz
Displacement speed	≤10 m/s
Max. acceleration	≤ 100 m/s ² displacement
Resolution	Infinite, limited by noise (10μm)
Working pressure	350 bar (peak max 500 bar)

ELECTRICAL DATA

Nominal power supply	18...30Vdc opt. 12Vdc (RK-4-_____-K)
Max. power ripple	1Vpp
Output signal	0,1...10,1Vdc (RK-4-_____-N) 0,1...5,1Vdc (RK-4-_____-K) 4...20mA (RK-4-_____-E) 20...4mA (RK-4-_____-R)
Max. analog output load	5KΩ
Output current consumption	max 40 mA (load on start/stop output: 300 Ω)
Electric isolation	100 Vdc
Protection against polarity inversion	Yes
Protection against overvoltage	Yes

ENVIRONMENTAL DATA

Protection	IP 67
Operating temperature	-30°...+90°C for strokes ≤ 2500 mm and power supply ≤ 24 Vdc otherwise -30...+70°C
Storage temperature	-40°...+100°C
Coefficient temperature	0.005% FS / °C

MECHANICAL DIMENSIONS

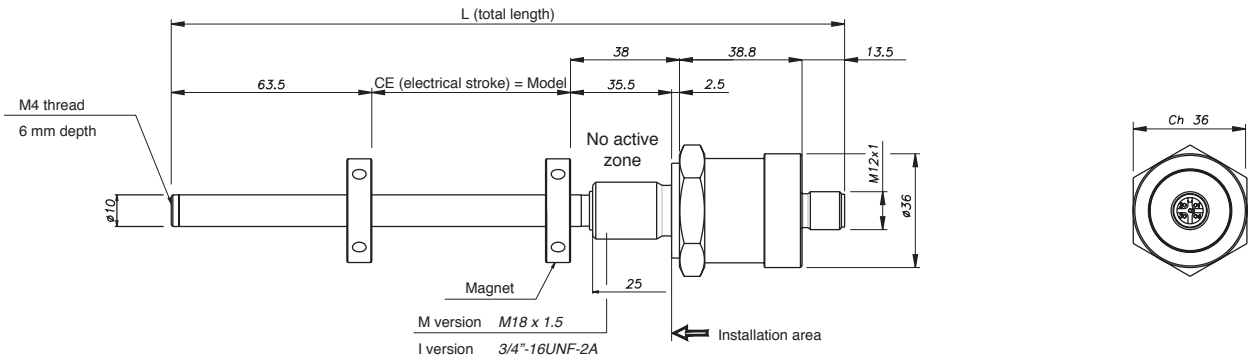

MOUNTING INSIDE A CYLINDER

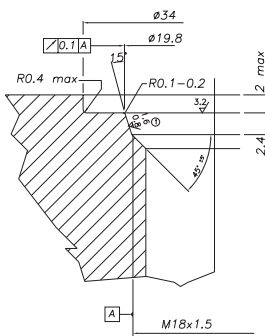
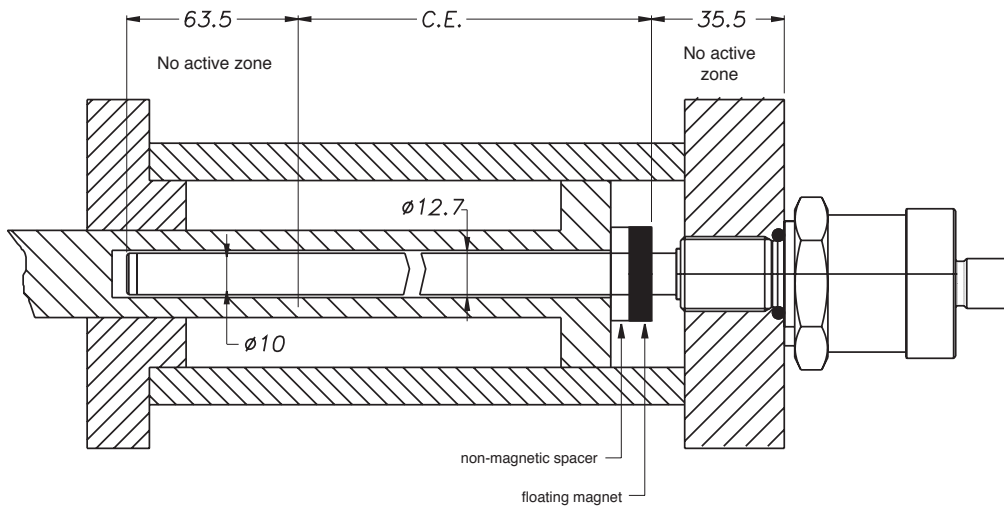

- 1 **THREAD M18x1,5**
 The seal surface must be free from winding or longitudinal scratches
 Ro 1.6 μ m for seals with NON pulsating pressure
 Ro 0.8 μ m for seals with pulsating pressure

Suggested O-Ring:
 PARKER 6-349 15.4x2.1
 Material: Viton 90° Shore-A
 Mixes: PARKER N552-90

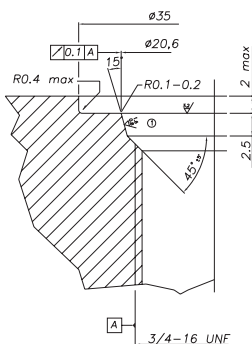
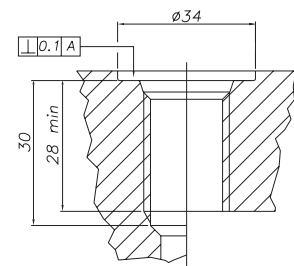

- 1 **THREAD 3/4"-16UNF**
 The seal surface must be free from winding or longitudinal scratches
 Ro 1.6 μ m for seals with NON pulsating pressure
 Ro 0.8 μ m for seals with pulsating pressure

Suggested O-Ring:
 PARKER 3-908 16.36x2.21
 Material: Viton 90° Shore-A
 Mixes: PARKER N552-90

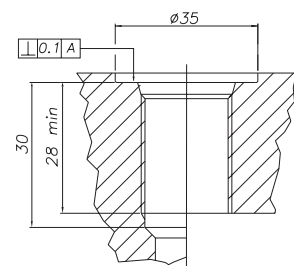

ELECTRICAL / MECHANICAL DATA

Model	50	100	130	150	200	225	300	400	450	500	600	700	750	800	900	1000	1250	1500	1750	2000	2250	2500	2750	3000	3250	3500	3750	4000	
Electrical stroke (C.E.)	mm	Model																											
Independent linearity		$< \pm 0.02\% \text{ F.S. (Min. } \pm 0.060 \text{ mm)}$																											
Max. dimensions (L)	mm	Model + 140.3 (excluding connector)																											
Repeatability	mm	< 0.01																											
Hysteresis		$< \pm 0.005\% \text{ F.S.}$																											
Sampling time	msec	1 (1.5 for strokes from 1100 to 2000) (2 for strokes from ≥ 2000)																											

ELECTRICAL CONNECTIONS (RK- 4 - _ _ _ _ - N/K/E/R)

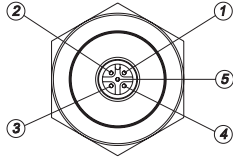

	RK-4- _ _ _ _ -N	RK-4- _ _ _ _ -K	RK-4- _ _ _ _ -E/R
1	Output 0.1...10.1Vdc	Output 0.1...5.1Vdc	Output 4...20mA or 20...4mA
2	Output GND	Output GND	Output GND
3	Do not connect	Do not connect	Do not connect
4	Power supply GND	Power supply GND	Power supply GND
5	Power supply +	Power supply +	Power supply +

ORDER CODE

Position
transducer

R K 4 [] [] [] []

Model

0 0 0 0 X 0 0 0 X 0 0 [] 0 X X

Threading

M18 x 1.5 (standard)	M
3/4"-16UNF (option)	I

Output

Analog	0.1...10.1Vdc interface (power supply 18...30Vdc)	N
Analog	0.1...5.1Vdc interface (power supply 12Vdc)	K(*)
Analog	4...20mA interface (power supply 18...30Vdc)	E
Analog	20...4mA interface (power supply 18...30Vdc)	R

(*) The maximum stroke for the K version is 1200mm

Mechanical and/or electrical characteristics differing from those in the standard version may be arranged on request.

FLOATING CURSOR (to order separately)



Cursors	
Cursor diameter 32.8	022
Cursor diameter 32.8 with 90° slit	023
Cursor diameter 25.4	024

Dimensions	A	B	C	Thickness
PCUR022	32.8	13.5	23.9	7.9
PCUR023				
PCUR024	25.4	13.5	-	

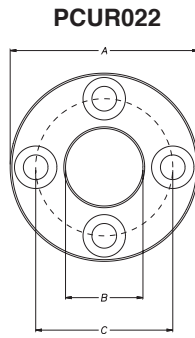

The **PCUR022** is supplied with:

N° 8 Brass nuts M4
 N° 8 Brass washers D4
 N° 4 Brass screws M4x25

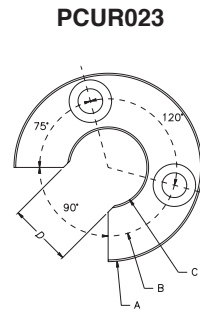

The **PCUR023** is supplied with:

N° 4 Brass nuts M4
 N° 4 Brass washers D4
 N° 2 Brass screws M4x25

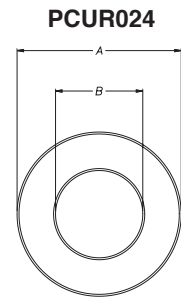

OPTIONAL ACCESSORIES (to order separately)

5-pin cable code			
Length "L"		CODE	
		Straight cable	Cable to 90°
2	mt	CAV011	CAV021
5	mt	CAV012	CAV022
10	mt	CAV013	CAV023
15	mt	CAV015	CAV024

Sensors are manufactured in compliance with:

- EMC 2014/30/EU compatibility directive
- RoHS 2011/65/EU directive

Electrical installation requirements and Conformity certificate are available on our web site: www.gefran.com

GEFRAN spa reserves the right to make any kind of design or functional modification at any moment without prior notice.