

# Series ISC

## Isolated Signal Converters



Model ISC-LC for load cells

*Isolated signal converters for load cell signals and for general mV signals with full scales of 30mV or less. Output configurable for mA or Vdc. Instrument to be mounted on standard DIN rail. Power options in AC and DC. Strong three way isolation between input, output and power circuits.*

# Converter ISC-LC

## Isolated Signal Converter for load cells and mV

Isolated signal converter for load cells and general mV signals with full scales of 30mV or less. The instrument does not provide excitation voltage to power-up the load cell.

Output signal configurable in 0/10Vdc, 4/20mA and other ranges. Instrument readjustable through jumpers and span and offset potentiometers accessible at the rear of the front cover.

Power option in AC and DC. Instrument to be mounted on standard DIN rail. Connections with plug-in screw terminals. For industrial applications.

High isolation levels between the input, output and power circuits, the instruments can be used as isolators between circuits together with the signal converter functionality.

The isolation provided prevents the propagation of transient peaks and energy discharges between circuits, thus protecting the remote acquisition systems. It also minimizes loop grounds, which if acquired with the signal, are very difficult to isolate.

### Order Reference

Model	Power	Input	Output
ISC - LC	0	0/20mV	4/20mA
	-0 (230 Vac 50/60 Hz) -1 (115 Vac 50/60 Hz) -6 (24 Vdc isolated)	-0/30mV -0/20mV -0/10mV	-4/20mA -0/10Vdc -...

### Precautions on installation



Risk of electrical shock. Instrument terminals can be connected to dangerous voltage.



Instrument protected with double isolation. No earth connection required.



Instrument is in conformity with CE rules and regulations. See "CE Declaration of Conformity" further in this document.

This instrument has been designed and verified according to the 61010-1 CE security regulation, and is designed for applications on industrial environments. See the "CE Declaration of Conformity" further in this document for information on the category of measure and the degree of pollution levels that apply.

Installation of this instrument must be performed by qualified personnel only. This manual contains the appropriate information for the installation. Using the instrument in ways not specified by the manufacturer may lead to a reduction on the specified protection level. Disconnect the instrument from power before starting any maintenance and / or installation action.

The instrument does not have a general switch and will start operation as soon as power is connected. The instrument does not have protection fuse, the fuse must be added during installation.

The instrument is designed to be panel mounted. An appropriate ventilation of the instrument must be assured. Do not expose the instrument to excess of humidity. Maintain clean by using a humid rag and do NOT use abrasive products such as alcohols, solvents, etc.

General recommendations for electrical installations apply, and for proper functionality we recommend : if possible, install the instrument far from electrical noise or magnetic field generators such as power relays, electrical motors, speed variators, ... If possible, do not install along the same conduits power cables (power, motor controllers, electrovalves, ...) together with signal and/or control cables.

Before proceeding to the power connection, verify that the voltage level available matches the power levels indicated in the label on the instrument.

In case of fire, disconnect the instrument from the power line, fire alarm according to local rules, disconnect the air conditioning, attack fire with carbonic snow, never with water.

### Instrument View

To access the jumpers for input and output range selection, and the span and offset adjust potentiometers, open the front cover by pressing on the A-A points indicated below.

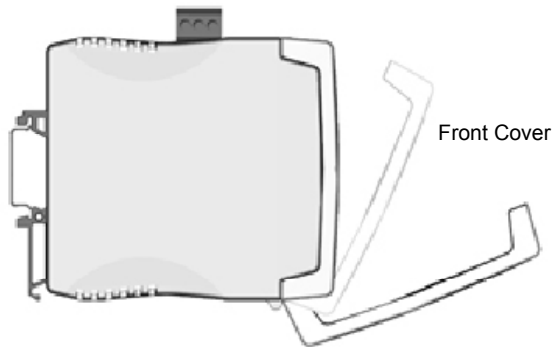
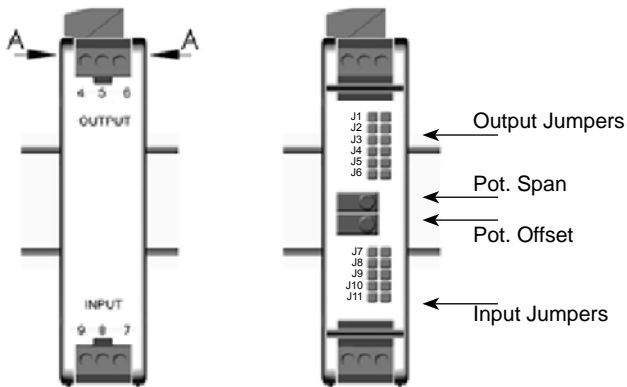

**IMPORTANT - Opening the front cover may grant access to areas with dangerous voltages. Operation must be performed by qualified personnel only.**

### Mounting

Install the instrument in vertical position, as indicated below. To help dissipate the heat, a free space of 2mm must be left available on both sides of the instrument.

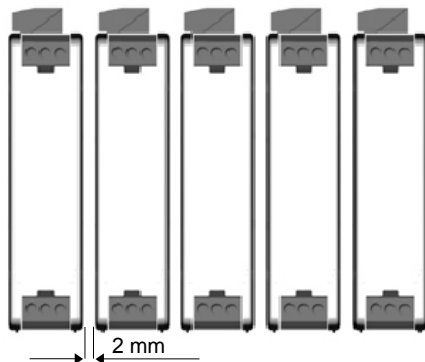

### Output Connections

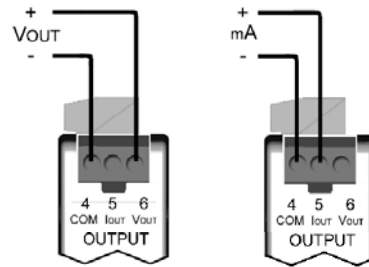

### Input Connections

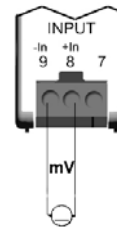

Signal in mV or load cell

### Power Connections

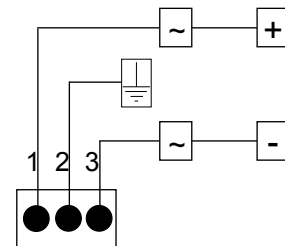

Earth connection - Although a terminal is offered for earth connection, the connection is optional. The instrument does not need this connection for correct functioning nor for compliance with the security regulations.

Fuse - To comply with security regulation 61010-1, add to the power line a protection fuse acting as disconnection element, easily accessible to the operator and identified as a protection device.

230 Vac	70mA time lag
115 Vac	100mA time lag
24 Vdc	250mA time lag

### Output range selection Jumpers

Place the jumpers in the appropriate position to select the desired output signal range.

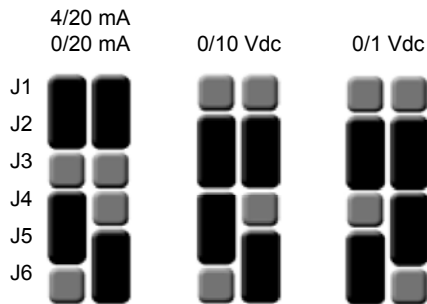

### Input range selection Jumpers

Place the jumpers in the appropriate position to select the desired input signal range.

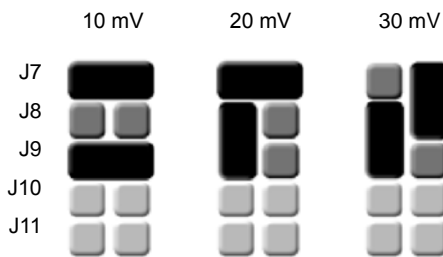

Note - load cell signals are defined by an output range proportional to the power voltage. Typical values are 1mV/V, 2mV/V and 3mV/V. For a power of 10V, the previous values are associated with 10mV, 20mV and 30mV signal ranges.

### Preoffset selection Jumpers

Place the jumpers in the appropriate position to select the desired preoffset range.

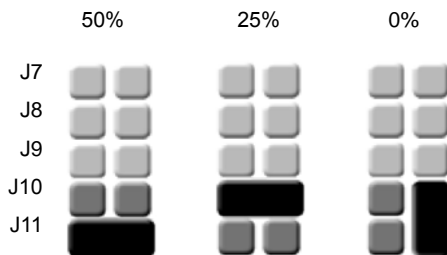

Note - Select 0% to disable the preoffset. Select 25% or 50% if required offset can not be reached with the front offset potentiometer.

### Readjustment procedure

To change the input/output relation of the instrument, select the appropriate jumper positions for input and output, and recalibrate the instrument as described below :

- 1- Open the front cover
- 2- Select the appropriate output range jumpers  
(Section "Output range selection Jumpers" in page 4)
- 3- Select the appropriate input range jumpers  
(Section "Input range selection Jumpers" and "Preoffset selection Jumpers" in page 4)
- 4- Connect a signal generator to the input terminals  
(Section "Input Connections" in page 3)
- 5- Connect a multimeter to the output terminals  
(Terminals 4 and 5 for mA or terminals 4 and 6 for Vdc)  
  
(Values in brackets are examples for an input/output adjustment of 0/20mV=0/10Vdc)
- 6- Generate the lower input signal (0mV)  
Operate the Offset potentiometer, until the output is at the low output value desired (0Vdc)
- 7- Generate the higher input signal (20mV)  
Operate the Span potentiometer, until the output is at the high output value desired (10Vdc)
- 8- Repeat steps 6 and 7, until the desired accuracy is reached
- 9.- Close the front cover



**IMPORTANT - Opening the front cover may grant access to areas with dangerous voltages. Operation must be performed by qualified personnel only.**

Technical Data

**Input signals** mVdc  
 Selectable ranges 0/30mV, 0/20mV, 0/10mV

Preoffset levels 0%, 25%, 50%

Excitation voltage not included  
 (use instrument FAR-1 as a stabilized power source for load cells.)

Input impedance 5MOhms

Overvoltages max. 15V

**Output signals** Vdc or mA  
 Selectable output ranges 4/20mA, 0/20mA  
 0/10Vdc, 0/1Vdc

Type active  
 Maximum output 22mA in current ranges  
 11Vdc in voltage ranges  
 Minimum output -1.5mA in current ranges  
 -1Vdc in voltage ranges  
 Minimum load in Vdc >1 KOhm  
 Maximum load in mA <400 Ohms

**Power**  
 in AC 230Vac 50/60 Hz  
 115Vac 50/60 Hz  
 in DC 24Vdc ±10% isolated  
 Consumption <3.8VA

**Configuration** input and output range selection jumpers, and span and offset potentiometers, accessible at the rear of the front cover

**Accuracy** 0.3% F.S. at 25°C  
**Linearity** 0.2% F.S.  
**Thermal stability** 250ppm/°C typ.

**Response time** <75mSec. (90% signal)

**Isolation** 3 way isolation  
 Input - Output 3500Veff (60 sec.), optical  
 Power - Input 3500Veff (60 sec.), galvanic  
 Power AC - Output 3500Veff (60 sec.), galvanic  
 Power DC - Output 1000Veff (60 sec.), galvanic

Technical Data (cont.)

**Mechanical**  
 Mounting standard DIN rail (35 x 7,5mm)  
 Connections plug-in screw terminals  
 Weight 120 grams (DC power)  
 200 grams (AC power)  
 Housing material Polyamide PA6 UL94 V-2 blue  
 Size DC models 22.5 x 93 x 110 mm  
 AC models 37.0 x 93 x 110 mm

**Protection** IP30

**Operating Temp.** 0 to 60°C  
**Storage Temp.** -20 to +70°C  
**Warm-up** 15 minutes

Mechanical Dimensions (mm)

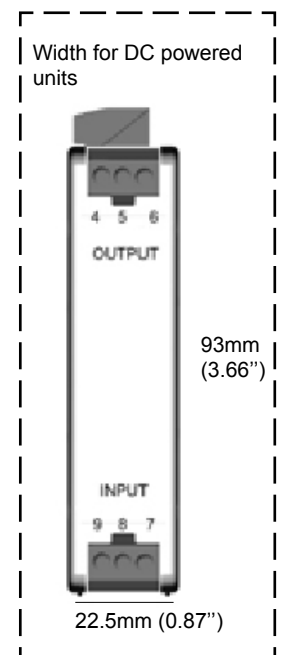
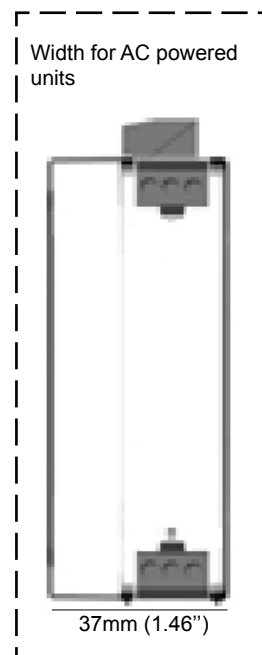
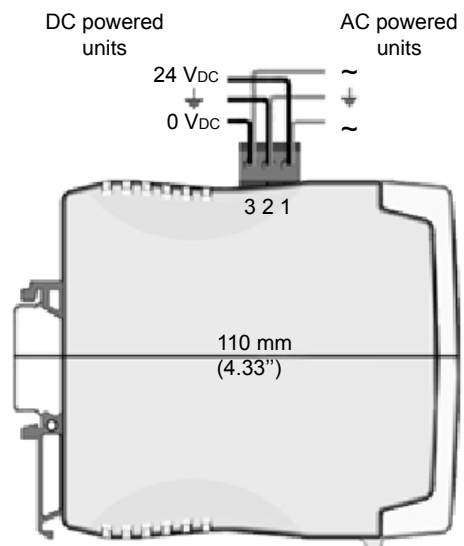

## CE Declaration of conformity

Manufacturer FEMA ELECTRÓNICA, S.A.  
 Pol. Ind. Santiga - Altimira 14  
 E08210 - Barberà del Vallès - BARCELONA  
 ESPAÑA - SPAIN  
 www.fema.es - info@fema.es

Security EN61010-1  
 Equipment "Fixed", "Permanently connected"  
 Degree of pollution 1 and 2 (without condensation)  
 Isolation Double  
 Category CAT-II

Series - ISC  
 Models P, PT100, TJ, TK, TE, TT, TR, TS, VAC, VDC,  
 IAC, IDC, POT, RES, HZ, LC

Immunity: EN 50082-2, IEC 1000-4-2, EN 61000-4-2,  
 IEC 801-2, ENV 50140, EN 61000-4-4, IEC  
 801-4 (level 3), ENV 50204 (level 3)

The manufacturer declares that the instruments indicated  
 comply with the directives and rules indicated below.

European directive for low voltage D73/23/CEE amended  
 by D93/68/CEE.

European directive for product safety D92/59/CEE

Electrotechnical regulation for low voltage (RBT) ITC 21,  
 ITC 29, ITC 35.

European directive for electromagnetic compatibility D89/336/  
 CEE amended by D93/68 CEE

Emission EN 50081-2, EN 55011, EN 55014, EN 55022,

UNE 21352-76: CEI 359-71 Operating quality expressions for  
 electronic equipment. UNE 20652-80: CEI 284-68 Behavior  
 rules inherent to the handling of electronic equipment and  
 other similar technics.

Barberà del Vallès, 2002

Daniel Juncà - Quality Manager

## Warranty

All instruments are warranted against all manufacturing  
 defects for a period of 24 MONTHS from the shipment date.  
 This warranty does not apply in case of misuse, accident or  
 manipulation by non-authorized personnel. In case of mal-  
 function get in contact with your local provider to arrange for  
 repair. Within the warranty period and after examination by  
 the manufacturer, the unit will be repaired or substituted when  
 found to be defective. The scope of this warranty is limited to  
 the repair cost of the instrument, not being the manufacturer  
 eligible for responsibility on additional damages or costs. .

THIS SECTION BLANK

# other products



Panel Meters  
Standard 96x48 mm



Panel Meters  
Small 72x36 mm



Panel Meters  
Miniature 48x24 mm



Large Displays  
60 & 100 mm digit



Signal Converters  
& Isolators



Panel Meters  
Standard 96x48 mm

[www.fema.es](http://www.fema.es)

ELECTRONIC INSTRUMENTATION FOR INDUSTRY

FEMA ELECTRÓNICA, S.A.  
Pol. Ind. Santiga - Altimira 14  
E08210 Barberà del Vallès - BARCELONA  
ESPAÑA - SPAIN

Tel. (+34) 93.729.6004 - [www.fema.es](http://www.fema.es)  
Fax (+34) 93.729.6003 - [info@fema.es](mailto:info@fema.es)